

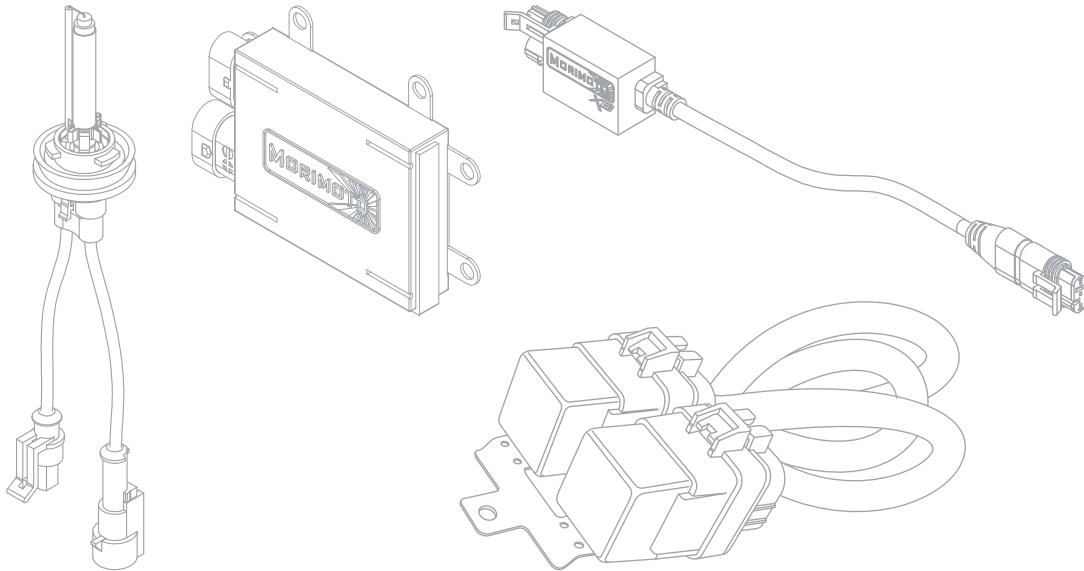

THE AUTOMOTIVE LIGHTING BENCHMARK



INSTALLATION GUIDE

5202/2504 ELITE HID SYSTEM







WARNING: By reading this document, I agree it is only to be used as an educational guide. Morimoto Lighting makes no guarantee on any finished results, nor are they to be held responsible for any damage, misuse, or personal injuries. Use at your own risk. If you are unable to clearly understand and adapt the information below to your own application, professional installation is recommended.

TABLE OF CONTENTS

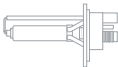

SYSTEM DIAGRAMS	P.3
EXTERNALLY-WIRED W/ CANBUS HARNESS	P.3
EXTERNALLY-WIRED W/ HD RELAY HARNESS	P.4
HARNESS INSTALLATION	P.5
BULB INSTALLATION	P.6
EXTERNALLY-WIRED BULB INSTALLATION	P.6
BALLAST INSTALLATION	P.7

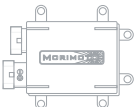
KIT CONTENTS

STANDARD PARTS

	1x TEST LEAD
	2x HID BULBS
	2x BULB WIRES
	2x BALLAST COMPUTERS
	2x AMP IGNITERS

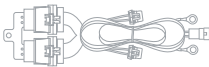
OPTIONAL PARTS

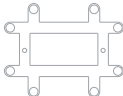
	2x CANBUS HARNESSES
	1x HD RELAY HARNESS
	1x CAPACITOR LINK
	2x CARBON FIBER BALLAST BRACKETS



Ballast Test Lead

The included ballast test lead is used for troubleshooting purposes only and is not part of the installation of this system. If necessary, the test lead can be plugged into the ballast input and then connected to a 12V+ source to test the ballast. This must be done with the bulb connected to the ballast prior to applying power.

SYSTEM DIAGRAMS



NOTE: System diagrams are to be used for reference purposes only. If you are unsure of the installation procedure for any individual part, review its install procedure prior to proceeding.

EXTERNALLY-WIRED W/ STANDALONE CANBUS

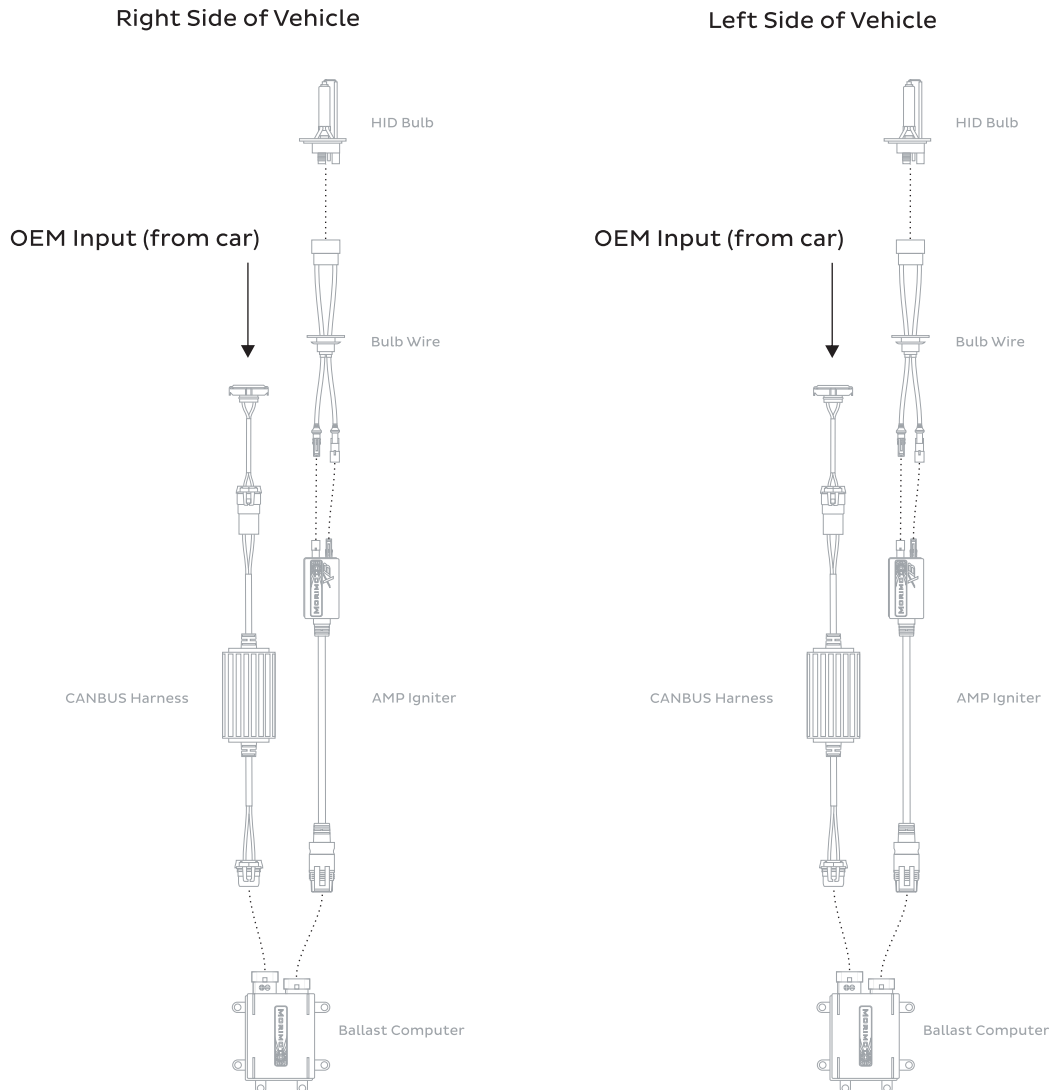

EXTERNALLY-WIRED W/ HD RELAY HARNESS

Side of vehicle
further from battery

Side of vehicle
closer to battery

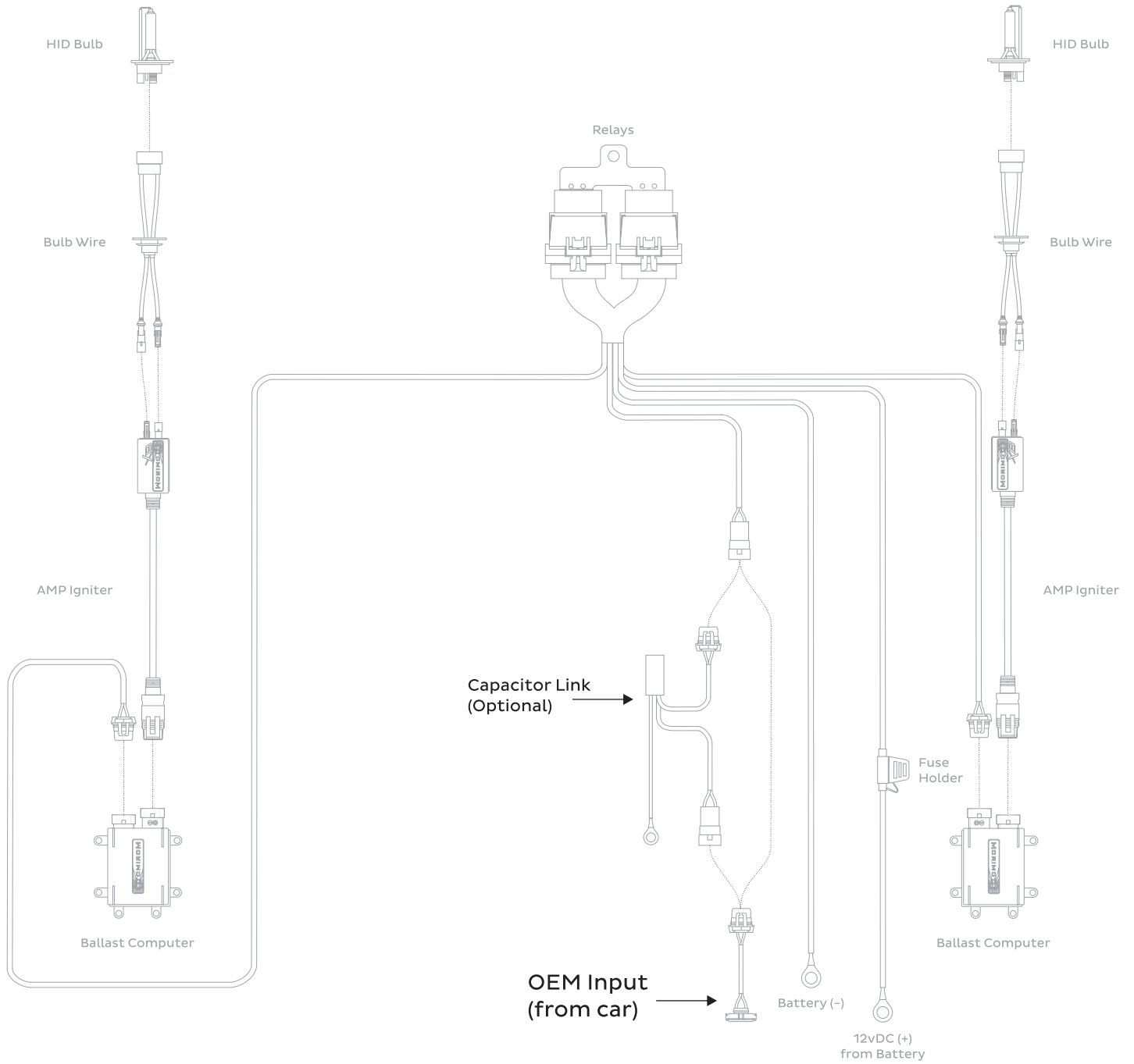

HARNESS INSTALLATION

SPECIAL NOTE: ALL HARNESS TYPES

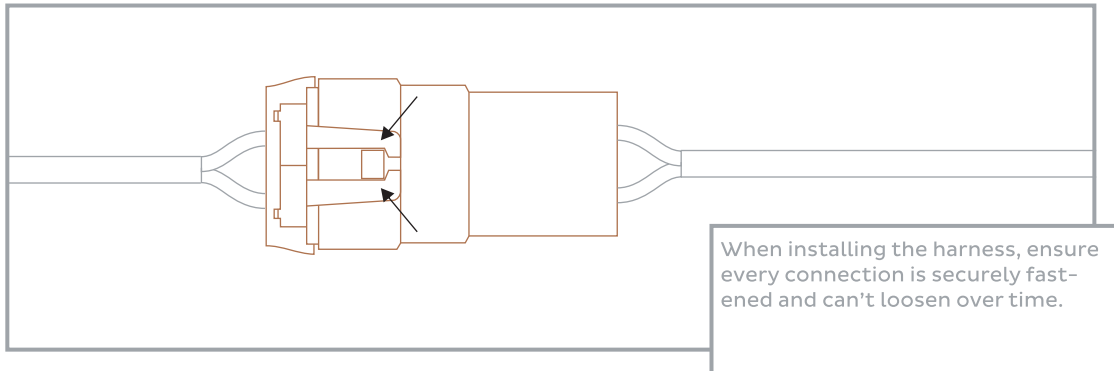

SPECIAL NOTE: HD RELAY HARNESS

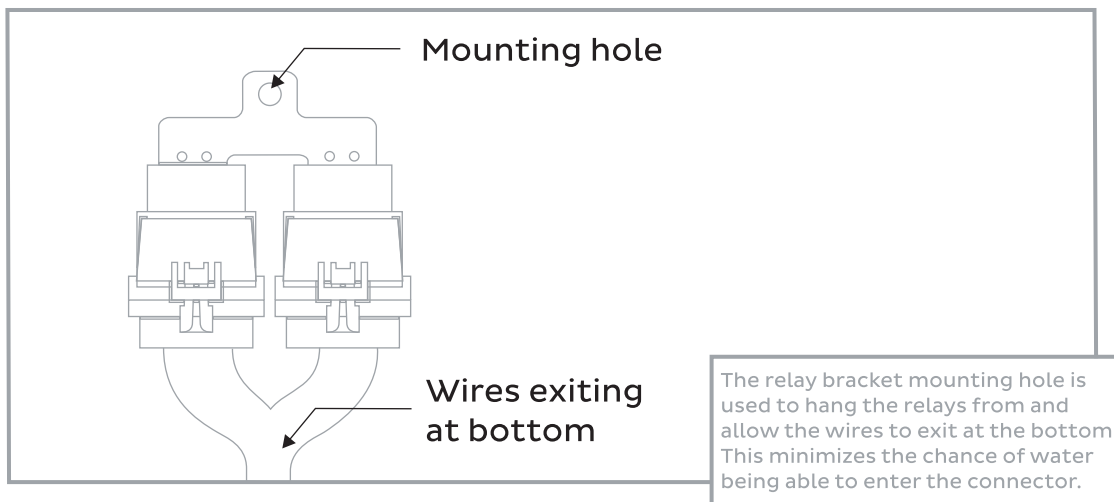

BULB INSTALLATION



CAUTION: HOT!



HANDLE ONLY WITH
BLACK PLASTIC BASE

STEP BY STEP - EXTERNALLY-WIRED

1

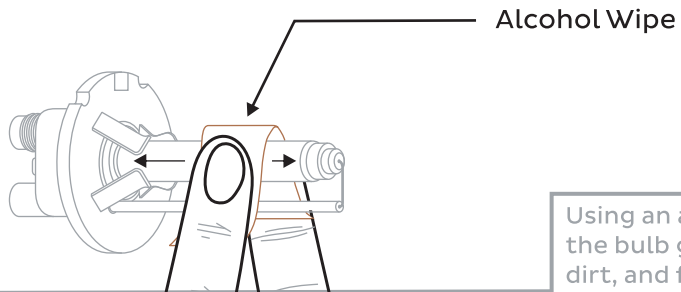

Using an alcohol wipe, clean the bulb glass of any dust, dirt, and finger prints.

2

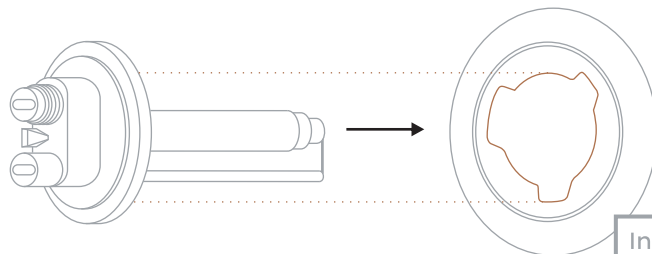

Install bulb into housing, replacing the stock halogen bulb.

3

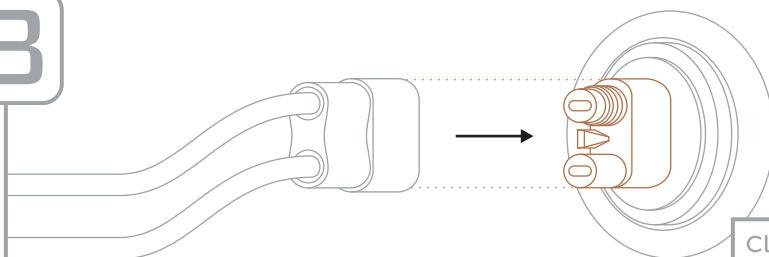

Click bulb wire connection onto bulb. Ensure side tab is fully latched.

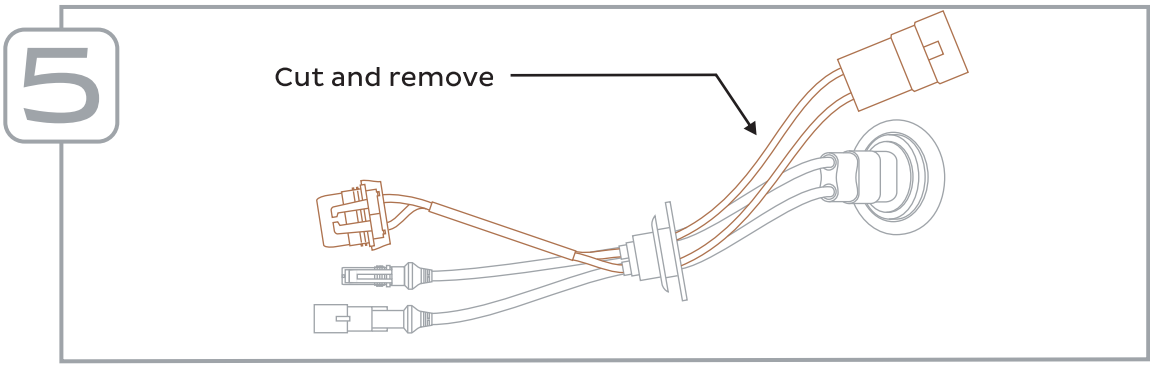
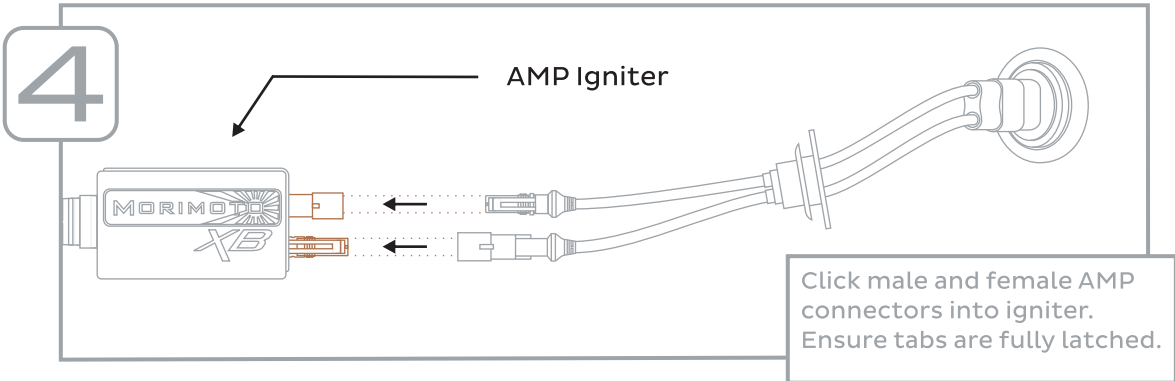

BALLAST INSTALLATION



DO NOT IGNITE UNTIL FULLY CONNECTED!



WATERPROOF

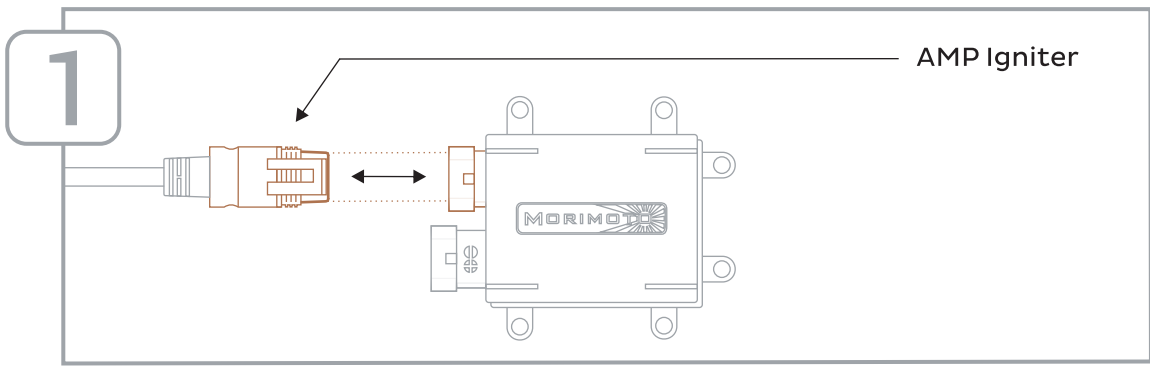

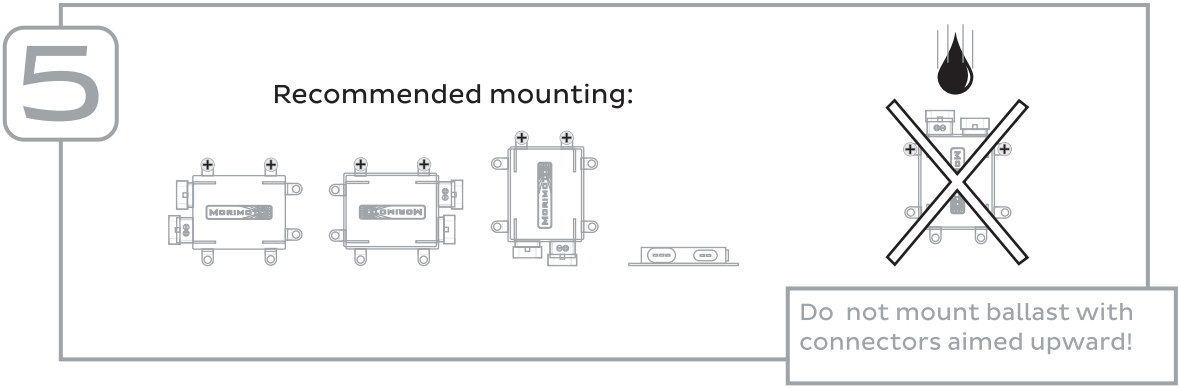
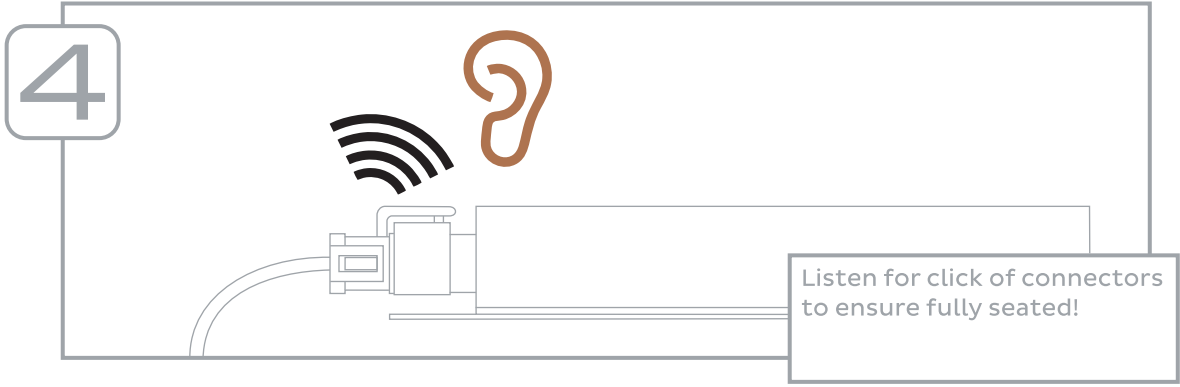
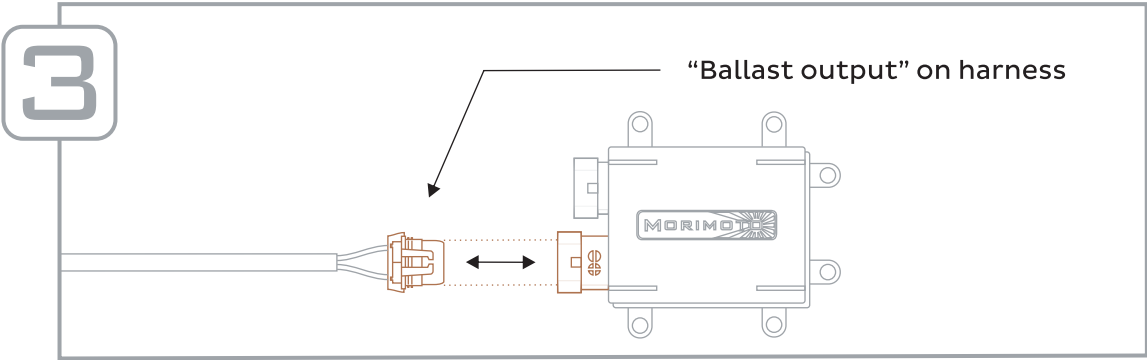
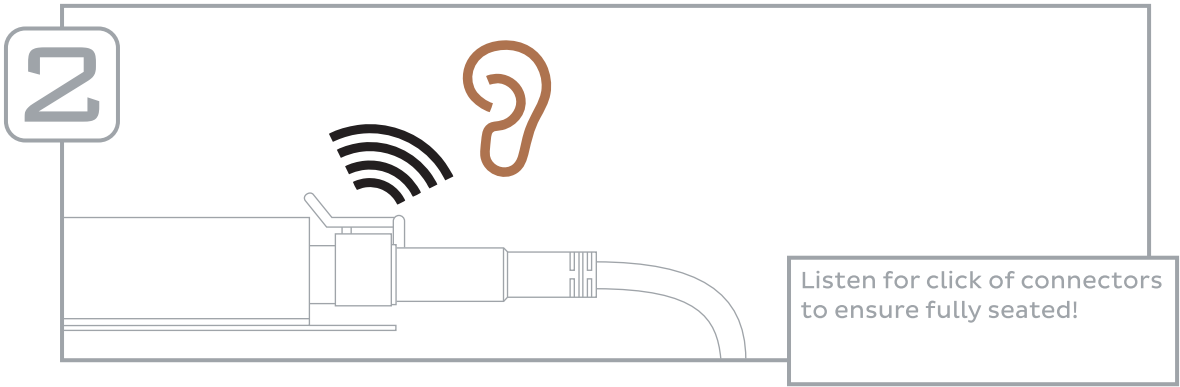

-END-