



INSTALLATION MANUAL

#27



FOR 24 VALVE 5.9L CUMMINS POWERED DODGE TRUCKS

2003 THROUGH 2004



MODEL RP-100 & RP-150

With New Quick Connect Components!

PLEASE READ THESE INSTRUCTIONS THOROUGHLY
BEFORE BEGINNING INSTALLATION

PureFlow AirDog

705 MAUSOLEUM ROAD
SHELBYVILLE, IN 46176

1-877-421-3187



www.pureflowairdog.com

RAPTOR

Fuel Pumps



*Wire Screen
Insert In Fuel Inlet
To Protect the Gerotor*

*Fuel Inlet
NOW
On Left Side*

*Adjustable
Regulator*



OVERVIEW



Welcome to the Raptor™ Fuel Pump!

The Raptor™ Fuel Pump is a Premium replacement lift pump for the Dodge Cummins 24 Valve 5.9L diesel engine. A complete installation kit is included.

The output pressure for the 5.9L 24 Valve Cummins engine is factory set at 15-18 PSI.

Pressure and flows are approximate as they will vary with fuel temperature and as the brushes wear in, also from variations of vehicle voltage/amp output and fuel line installation.

The RP-100 is recommended for stock and slightly modified 5.9L Cummins Diesels.

The RP-150 is recommended for highly modified 5.9L Cummins Diesels.

The Raptor™, a gerotor fuel pump, features an adjustable pressure regulator and has a protective wire screen insert at the fuel inlet.

*PureFlow AirDog Products are Manufactured with a Personal Touch,
Unsurpassed Attention to Detail
And
The Most Stringent Quality Assurance!*

TYPICAL DODGE CUMMINS INSTALLATION LAYOUT!

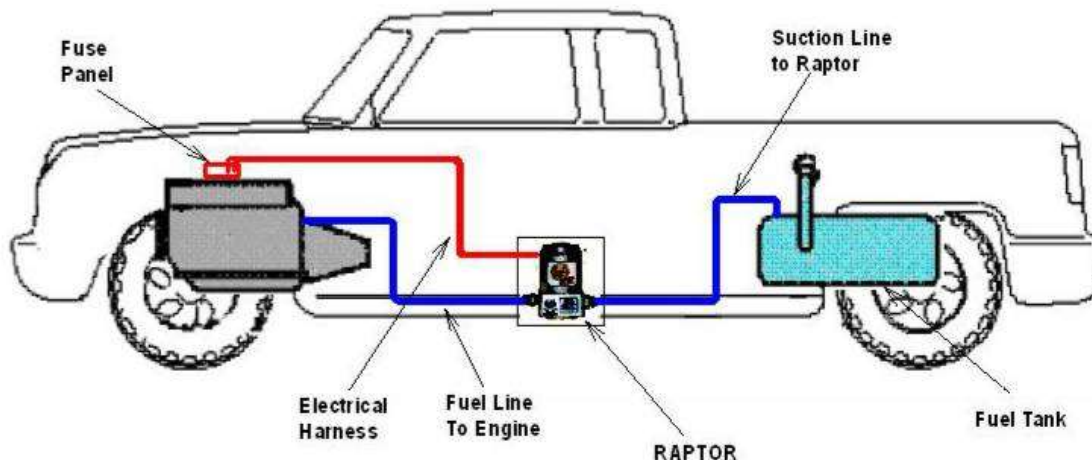

Figure 1

NOTE: The pictures used in this manual are for example only and may not picture components exactly the same as found on your truck.

QUICK CONNECT COMPONENT OVERVIEW

Provided in this kit is an OE style quick connection system. This system allows a quick, clean, and professional install.

SAE J2044 Quick Connect System

The SAE J2044 quick connect system is the most commonly used system in the automotive industry. The images below show the formation of SAE J2044 connection. To connect the assemblies, simply insert the male end form into the mating female connector. Push firmly until you hear it “click” into place. To disconnect the fittings, press down and hold the blue tabs on the female connector while you firmly pull the assembly apart.



TABLE OF CONTENTS

Section 1.....Table of Contents
Section 2.....Safety Guidelines
Section 3.....Parts List

INSTALLATION PROCEDURES

Section 4.....Raptor™ & Mounting Brackets

FUEL LINES

Section 5.....Fuel Line Assembly
Section 6A.....Raptor™ to Filter Canister
Section 6B..... Raptor Suction Line

ELECTRICAL HARNESS

Section 7.....Electrical Harness
Section 8.....Final Check List
Section 9.....Cleaning Debris From Gerotor

Raptor™

MODEL RP-100 & RP-150

The installation of the **Raptor™ Fuel Pump** can be made relatively easy by following the steps outlined in this manual.

1. Inventory the package components completely. Notify *PUREFLOW AIRDOG*. immediately of any parts missing or damaged.
2. Read the installation manual and understand how the system operates before beginning installation.
3. The installation recommendations contained herein are suggested installation guidelines only. Individual installations may vary.
4. If any installation procedure is uncertain, contact *PUREFLOW AIRDOG*. for technical assistance.

NOTE: Some of the pictures used in this manual are for example only and may not picture a component exactly the same as found in your truck.

SAFETY GUIDELINES!

- CAUTION:** Proper location of the Raptor™ on the vehicle is essential. Consider hazards presented to the equipment by road debris and the elements.
- CAUTION:** Chock the vehicle's tires to prevent rolling.
- CAUTION:** Disconnect the battery cables to both batteries before proceeding with the Raptor™ Fuel Pump installation.
- CAUTION:** Vehicle frame rails should not be drilled into or welded upon.
- CAUTION:** Wear safety glasses when operating power tools such as drills and grinders or when using a punch or chisel.
- CAUTION:** Use common sense when routing fuel lines and electrical harnesses. Keep them away from hot exhaust components and/or moving parts. Properly secure lines to prevent chaffing.

Use Good Judgment and Common Sense When Installing the Raptor™!



Parts List



QTY	DESCRIPTION	PART NUMBER	IMAGE
1	RAPTOR™ FUEL PUMP	RP-100 or RP-150	
1	WIRING HARNESS	5E-2-013	
1 Set	MOUNTING BRACKETS	010-3C-0002PC 010-3C-0001PC	
1	Mounting Hardware Kit	901-61-0102-PM-RP	
1	Cable Ties	5H-2-1-06/12	
1	Spacer	010-3C-0003-A-P	
1	14ft of Fuel Line	HS14	
2or3	1/2" Straight Hose Quick Connect Fitting <i>(3 for R2SBD356 Only)</i>	FQC12S	
1	1/2" 90° Hose Quick Connect Fitting	FQC1290	
1	3/8" Straight Hose Quick Connect Fitting <i>(0 for R2SBD356)</i>	FQC38S	
1	Customer Service O-ring Replacement Kit	901-05-0101	
2	1/2" Male QC x 3/4-16 ORB	08J2044-3/4UNF	
1	Fuel Filter Canister Inlet Fitting	001-4A-1-0005ZB	
1	Oring (installs on 001-4A-1-0005ZB Fitting)	1U-2-1-112	
1	Fuel Module Up Grade Kit (R2SBD356 only)	901-01-0510	

ILLUSTRATION OF QUICK CONNECT COMPONENTS

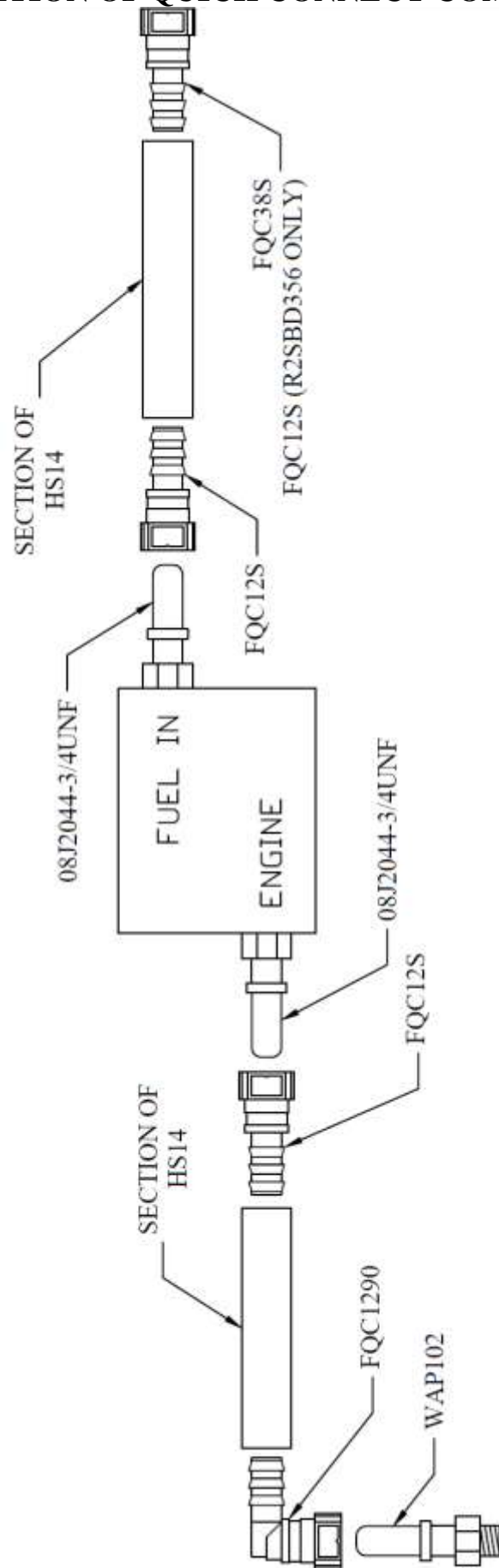

Assembling the Fuel Lines

This kit includes a length of fuel line and separate fuel line ends to allow for much cleaner looking installations! Assemble the fuel lines as you install them. You won't want to pre-assemble the hoses or your lengths may be off.

- 5-1. Take the fuel line end and lubricate the barbed end with clean motor oil (Figure 7) and press it into the fuel line (HS14) until all three barbs are covered (Figures 8 and 9). The fuel line end should look like Figure 9.



Figure 7



Figure 8



Figure 8

- 5-2. Now plug that fuel line with that fitting into the connection on the either the Raptor or the truck where the manual calls it out.
- 5-3. Run the fuel line along the frame away from any hot or moving parts such as exhaust or the driveshaft (Figure 10). Cut the hose to length and insert the other fuel line end that the manual calls out into the fuel line as outlined in step 5-1.



Figure 10

NOTE: Hose clamps are not needed for these push-lock connectors.

Section 6A: Connecting the Raptor™ to the Filter Canister.

6A-1. Remove the Lift Pump and fuel supply line from the original factory fuel filter canister.



Figure 11



Figure 12

6A-2. Install the Fuel Filter Canister Inlet Fitting (001-4A-1-0005ZB) with O-ring into the inlet port on the fuel filter canister with the original pump mounting screws. Properly torque the fitting.

Connecting the Raptor™ fuel outlet to the filter canister inlet!

6A-3. Assemble one end of the hose (Reference section 5) using fuel line end FQC1290 and plug it into the 001-4A-1-0005ZB fitting installed in the previous step. A “click” will be heard once the fitting is properly connected.

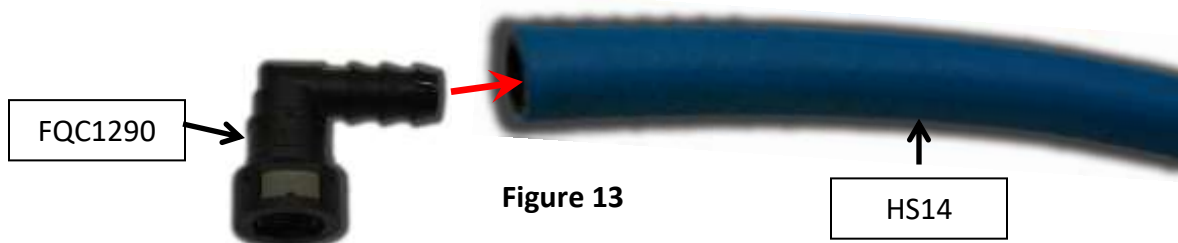

Figure 13

6A-4. Run the fuel line along the frame as mentioned in step 5-3 to the “Out” port in the Raptor®. Cut the fuel line to length and insert fuel line end FQC12S per step 5-1. Once the connector is installed, connect it to the male J2044 fitting in the “Out” port in the Raptor®. A “click” will be heard once properly connected.



Figure 14

Section 6B

Fuel Lines (Suction Line)

Section 6B: Fuel Suction Line for Raptor

NOTE: If you purchased kit R2SBD356 (W/ In-tank pump), follow the instructions in the fuel module upgrade kit. Otherwise proceed to 6B-1

6B-1. Remove the original fuel suction line Quick Connect fitting from fuel tank by squeezing the tabs on the end of the connector together. Consult factory manual if unsure.

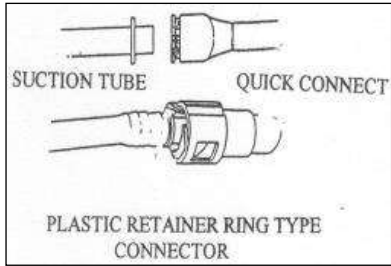

Figure 15



View From Beneath Bed

Figure 16



Figure 17

6B-2. **VERY IMPORTANT:** After removing the factory line check to make sure that the blue plastic retainer was removed with the line. If the blue retainer remained attached to the tank tube, it **MUST** be removed before the new fuel line Quick Connect will connect and seat to the tank suction tube.

6B-3. Assemble one end of the fuel line (Reference section 5) using fuel line end FCQ38S and plug it into the male connection to where the factory suction line was just removed in the previous step. A “click” will be heard once properly connected.



6B-4. If you have kit R2SBD356, assemble one end of the fuel line using fuel line end FQC12S and plug it into the fuel module upgrade bulk head fitting that was installed. You will hear a “click” once properly installed.

6B-5. Run the other end of the fuel line along the frame as mentioned in step 5-3 to the Raptor™ “In” port. Cut the fuel line to length and insert fuel line end FQC12S per step 5-1. Once the fuel line end is pressed in, connect it to the male J2044 fitting in the Raptor™ “In” port. A “click” will be heard once properly connected.



The **Raptor™ Fuel Pump** is equipped with a relay controlled wiring harness that is activated through the OE fuel pump connection.

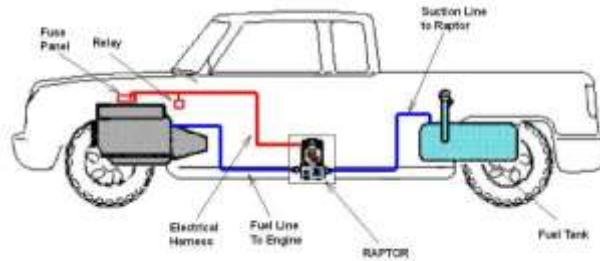

Figure 20

Securing the Relay and Fuse Holder to the Vehicle.

- 7-1. Secure the relay and fuse holder to the vehicle on the firewall near the steering column or a more suitable location, if appropriate.



Figure 21



Figure 22

Connecting the Raptor™ to the ECM Lead.

- 7-2. Disconnect the OE fuel pump lead at the ECM connector (Deutsch two pin connector). Carefully route and connect the Raptor™ ECM lead (Deutsch, two pin Connector) to the ECM pump lead. **This lead can be found behind and below the stock filter canister in the same location as the stock pump.**



Figure 23

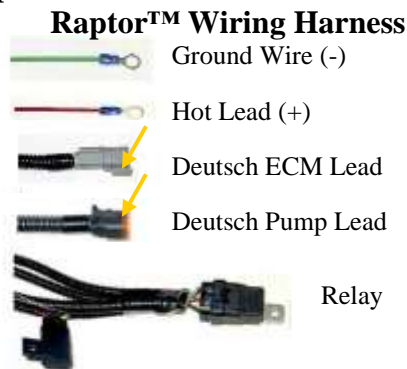

Figure 24



Figure 25

- 7-3. Route the wiring harness lead with the Deutsch Pump Lead to the Raptor™. Connect the pump lead on the wiring harness to the corresponding lead on the Raptor™.

Connecting the Raptor™ Power Supply Leads.

NOTE: The “Hot Lead” & “Ground Wire” can be connected to either the **Alternator, Figure 26 & 27;** or the **Battery, Figure 28.**

Connecting the power supply leads to the alternator instead of the battery will create a corrosion free connection.

Green (-)

Red (+)



Figure 26

Replace the Protective Cover



Figure 27

- 7-4. Route the Red & Green power supply leads to the alternator. Connect the Green (-) lead to the alternator *Chassis Ground* connection. Connect the Red (+) lead to the alternator *Hot Lead*.
- 7-5. To connect to the battery, connect the RED (+) lead to the POSITIVE (+) post of the driver's side battery. Connect the GREEN (-) lead to the NEGATIVE (-) post of the same battery.

Green (-)

Red (+)

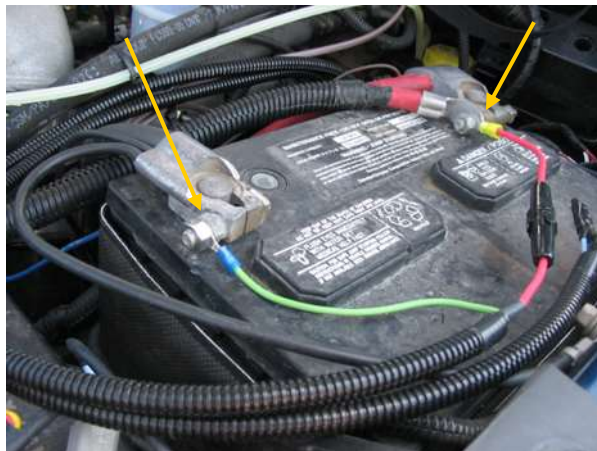

Figure 28

BE SURE TO PROPERLY SECURE THE WIRING HARNESS TO THE VEHICLE!.

Initial Start Procedure.

8-1. Turn the starter key to the on/run position.

NOTE: It may be necessary to momentarily engage the starter for the ECM to energize the **Raptor™ Fuel Pump**.

8-2. While the **Raptor™ Fuel Pump** is on, bleed the fuel line to the filter canister by loosening the fuel line connection at the canister. As soon as the line is purged of air and fuel is observed, properly tighten the fuel fitting. **NOTE:** put a rag or shop towel over and around the fitting to prevent splatter. Catch all spilled fuel and dispose of properly.

8-3. Start engine!

Adjusting the Pressure Regulator!

To adjust the fuel pressure, loosen the lock nut on the regulator adjustment screw. Using a flat blade screw driver, rotate the adjustment screw clockwise to increase pressure or counter clockwise to decrease pressure. Be careful not to loosen the regulator assembly base. If you do, tighten it immediately. When finished, properly torque the regulator adjustment screw lock nut!

Properly tighten the adjustment screw **Lock Nut** when finished.

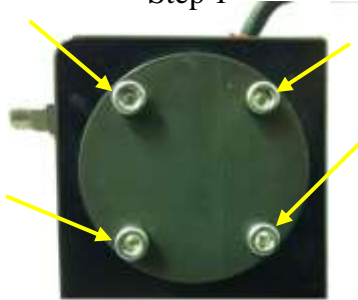

Figure 22

RECHECK ALL FUEL FITTINGS FOR LEAKAGE AND PROPERLY TORQUE AS NECESSARY. BE SURE ALL FUEL LINES ARE PROPERLY ROUTED TO PROTECT FROM EXCESSIVE HEAT AND SECURED TO PROTECT FROM CHAFFING AND ABRASION. RECHECK ALL ELECTRICAL LINES, SECURE AS NECESSARY.

Cleaning Debris from the Raptor Pump Gerotor Assembly.

Step 1



Remove the four (4) socket head cap crews that secure

Step 2



Carefully remove the O-ring, you will need to re-use it.

Step 3



Remove and clean the gerotor. **The rotor should come out very easily. If it doesn't there may be something jammed inside it.**

Step 4



Remove the O-rings and clean the inside of the gerotor pocket.

Step 5



Replace the center gear.

Step 6



Align and install the outer gear and O-rings.

Step 7

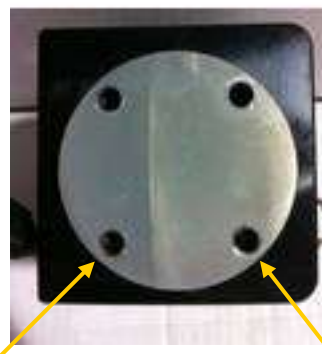

Install the gerotor cap. Be very careful not to dislodge or pinch the O-rings. Tighten the cap screws in an opposing pattern.

PUREFLOW AIRDOG
LIFETIME LIMITED EXPRESS WARRANTY

FOR
Covered PureFlow AirDog I, II and Raptor Systems

IMPORTANT NOTICE

TO ACTIVATE YOUR PUREFLOW AIRDOG WARRANTY, YOU MUST COMPLETE AND MAIL YOUR WARRANTY CARD TO PUREFLOW AIRDOG WITH A COPY OF YOUR ORIGINAL SALES RECEIPT WITHIN 30 DAYS OF PURCHASE. FAILURE TO COMPLETE AND SUBMIT YOUR WARRANTY CARD WILL RESULT IN A WARRANTY PERIOD OF THE COVERED PRODUCT TO ONE (1) YEAR FROM THE DATE OF PURCHASE.

PureFlow AirDog (hereafter collectively, “SELLER”) warrants and guarantees only to the Original Purchaser (hereafter collectively, BUYER) that All PureFlow AirDog Systems (hereafter collectively, PRODUCT) shall be free from defects of materials and workmanship in the manufacturing process for as long as the BUYER owns the PRODUCT.

The Lifetime Limited Express Warranty is limited to the PRODUCT purchased by the original BUYER of the PRODUCT and limited solely to the parts contained within the PRODUCT and EXCLUDES ALL ELSE INCLUDING FILTERS AND WATER SEPARATORS. Any PRODUCT that is in question of Warranty must be returned, shipped prepaid, to PureFlow AirDog. All Warranty claims are subject to the approval of PureFlow AirDog. If it is determined that a Warranty claim exists, PureFlow AirDog will, at its sole discretion, replace the defective PRODUCT with a comparable PRODUCT, repair the defective PRODUCT, or refund the BUYER’S purchase price in exchange for the PRODUCT. Repairs or replacements are warranted for only the remainder of the original warranty period and only to the original BUYER.

Under no circumstances shall the SELLER be liable for any labor charged or travel time incurred in the diagnosis for defects, removal, or reinstallation of the PRODUCT, or any contingent expense.

Under no circumstances will the SELLER be liable for any damage or expense incurred by reason of the use or sale of the PRODUCT.

Other than expressly set forth herein, the SELLER shall in no way be responsible for the proper or improper use and service of the PRODUCT. In no event shall the SELLER be liable for any special, incidental, indirect or consequential damages of any kind or nature, whether or not the BUYER of the PRODUCT was advised of the possibility of damage or harm, arising or resulting from the use or performance of the PRODUCT and BUYER hereby waives the right to any and all such claims.

BUYER, acknowledges that he/she is not relying on SELLER’S skill or judgment to select or furnish goods suitable for any particular purpose and that SELLER has no liability that will extend beyond the scope of the LIMITED EXPRESS WARRANTY contained herein, and BUYER hereby waives all remedies or liabilities, expressed or implied, arising by operation of law or otherwise.(including, without limitation, any obligation of SELLER with respect to fitness for any particular purpose; merchantability; and special, incidental, indirect or consequential damages) or whether or not occasioned by SELLER’S negligence.

SELLER disclaims any warranty and expressly disclaims any liability for personal injury or damages related to BUYER’S use of the PRODUCT. BUYER acknowledges and agrees that the disclaimer of any liability for personal injury is a material term for this agreement and BUYER agrees to indemnify SELLER and hold SELLER harmless from any claim related to the PRODUCT and its use or performance. Under no circumstances will SELLER be liable for any damages, liabilities, costs or expenses incurred as a result of or by reason of use, performance or sale of the PRODUCT, including without limitation, any damages, liabilities, costs or expenses incurred by reason of BUYER’S negligence related to those uses of the PRODUCT.

The proper installation of the PRODUCT is the sole responsibility of the BUYER. The SELLER assumes no liability regarding improper installation or misapplication of the PRODUCT.

SELLER hereby provides the following limited warranty as to description, quality, merchantability, fitness for the PRODUCT’S purpose, productiveness, or any other matter of SELLER’S PRODUCT sold herewith. The SELLER

shall be in no way responsible for the open use and service of the PRODUCT and the BUYER hereby waives all rights other than those expressly written herein. This Warranty shall not be extended or varied except by a written instrument signed by SELLER and BUYER.

IN THE EVENT THAT THE BUYER DOES NOT AGREE WITH THIS AGREEMENT, THE BUYER MAY PROMPTLY RETURN THE PRODUCT, IN A NEW AND UNUSED CONDITION, WITH A DATED PROOF OF PURCHASE, TO THE PLACE OF PURCHASE WITHIN THIRTY (30) DAYS FROM THE DATE OF PURCHASE FOR A FULL REFUND. THE BUYER AGREES THAT THE INSTALLATION OF THIS PRODUCT CONFIRMS THE BUYER HAS READ AND UNDERSTANDS THIS AGREEMENT AND ACCEPTS THE TERMS AND CONDITIONS OF THIS AGREEMENT.

Warranty Procedure

In the unlikely event a warranty appears as if it may be warranted, the following steps are taken:

- 1 The customer discussed the symptoms of the problem with a PureFlow AirDog Technician. The customer is to have the system Serial Number and Model Number available for the Technician when the call is made. This will expedite all steps of the process.
- 2 The customer performs any and all tests requested by the PureFlow AirDog Technician. This is done to isolate the potential problem while eliminating potential installation or maintenance related issues,
- 3 If the PureFlow AirDog Technician determines based on the customer feedback concerning the requested testing that system may be at fault, the customer is advised that all returned pumps are tested upon arrival and should this returned pump perform at design criteria upon arrival, the customer will be charged a \$50.00 fee.
- 4 The PureFlow AirDog Technician will first request the customer's phone number in the event the phone call is accidentally disconnected and then transfer the customer to a PureFlow AirDog Customer Service Representative. Should a Customer Service Representative not be available, the Technician will offer the Customer the option to hold, call back, or receive a return call.
- 5 The PureFlow AirDog Customer Service Representative will check to determine if the customer's Warranty Registration Card is on file.
 - a. If no Warranty Registration is found, the customer will be required to supply the original purchase receipt showing the purchase date.
 - b. If no Warranty Registration is found, the customer will be advised of the options should the system in question is out of the default warranty period (1 year).
- 6 The PureFlow AirDog Customer Service Representative will request the customer information, including: Name, Address, Phone Number, Model Number, Serial Number, Year / Make / Model of vehicle, Name of Dealer purchased from, Purchase Date, Description of Problem, Customers' understanding of the resolution, and customer credit card information.
- 7 PureFlow AirDog will cover Ground Shipping charges to ship the replacement unit and will include a prepaid shipping label for the return of the defective unit. Any additional items ordered at the time of the replacement shipment will include their portion of the shipping cost.
- 8 A period of 15 Calendar Days from the time of shipment is provided for the receipt of the defective unit at the PureFlow AirDog facility. Failure to return ship the defective unit to arrive within the defined time period will result in a charge of \$250.00 against the customer's credit card as the purchase cost of the defective unit.