

Owner's Manual with Installation Instructions

Banks iDash[®] 1.8 Super Gauge

2008 & later vehicles with CAN equipped OBDII

THIS MANUAL IS FOR USE WITH PART NUMBER 66560, 66560-DL, 66561, 66561-DL, 66562, & 66562-DL

PROTECTED BY U.S. Patent 7,254,477 B1 U.S. Patent 7,593,808 B2

Gale Banks Engineering
546 Duggan Avenue • Azusa, CA 91702
(626) 969-9600 • Fax (626) 334-1743

Product Information & Sales: (888) 635-4565
Customer Support: (888) 839-5600
Installation Support: (888) 839-2700

bankspower.com

Introduction

Welcome to the world of Banks iDash MMI 1.8

Congratulations on your Banks iDash 1.8 (hereafter simply referred to as the **iDash**) purchase. You're about to discover that the iDash is designed to help you get the most out of your entire driving experience. Besides being fun and easy-to-use, the iDash's graphic, intuitive design makes each screen and feature a breeze to navigate. Use this manual to get you started. As the iDash develops, we will be updating this manual both in print and online at **bankspower.com/manuals**.

With your iDash, you now have the most sophisticated and user friendly way to interact with your vehicle. Choose, select and change gauges in the display, change on-screen safety alerts, log vehicle data, interact with other Banks devices — all on-the-fly and at the touch of a button. With the iDash, you can also scan and clear OBDII diagnostic codes. It gives you virtually endless functionality and fits in an optional mount on your windshield or most mounts with a 52mm / 2 1/16" hole. The iDash is a standalone vehicle data system that gives you the ability to monitor engine vitals that are not found on your factory dashboard display.

Product Registration

Don't forget, we're always working on expansions, upgrades, and new applications that will make your iDash do even more. So be sure to register at **www.bankspower.com/contact/productregistration** to receive important e-mail alerts regarding updates and upgrades for your iDash device. Or call us with questions at **1-800-GET POWER**.

Table of Contents

Introduction	2
Disclaimer of Liability/Warranty	5
End User License Agreement	7
1. Safety Precautions	7
2. Mounting and Connecting the iDash	10
Basic Setup	10
Daisy Chain	12
3. Software Intro/Navigation	13
iDash Menu Tree	15
4. Gauge Selection	16
Layout	16
Parameter Selection	18
5. Data Logging	18
Start/Stop Data Log	18
Change Parameters to be Data Logged	18
Format	19
6. Diagnostics	20
Trouble Codes	20
Emissions Readiness	21
7. Alerts	22
8. Min/Max Values	23
9. Shift Light	24
Banks Modules	25
10. Settings	26

Layout	26
Brightness	27
Bar Graph	27
Text Color	28
Units	28
Vehicle Selection	30
Wakeup Sensitivity Level	30
Reset	30
11. System Information	31
12. Firmware Update	32
13. Glossary	33
Density Overview	33
Data Definitions	34
14. Troubleshooting	38

Disclaimer of Liability & Warranty

Gale Banks Engineering Inc., and its distributors, employees, and dealers (hereafter "SELLER") shall in no way be responsible for the product's proper use and service. The BUYER hereby waives all liability claims.

The BUYER acknowledges that he/ she is not relying on the SELLER's skill or judgment to select or furnish goods suitable for any particular purpose and that there are no liabilities which extended beyond the description on the face hereof and the BUYER hereby waives all remedies or liabilities, expressed or implied, arising by law or otherwise, (including without any obligations of the SELLER with respect to fitness, merchantability, and consequential damages) whether or not occasioned by the SELLER's negligence. The BUYER is responsible to fully understand the capability and limitations of his/her vehicle according to manufacturer specifications and agrees to hold the SELLER harmless from any damage resulting from the failure to adhere to such specifications.

The SELLER disclaims any warranty and expressly disclaims any liability for personal injury or damages. The BUYER acknowledges and agrees that the disclaimer of any liability for personal injury is a material term for this agreement and the BUYER agrees to indemnify the SELLER and to hold the SELLER harmless from any claim related to the item of the equipment purchased. Under no circumstances will the SELLER be liable for any damages or expenses by reason of the use or sale of any such equipment.

The BUYER is responsible to obey all applicable federal, state, and local laws, statutes, and ordinances when operating his/her vehicle, and the BUYER agrees to hold SELLER harmless from any violation thereof.

The SELLER assumes no liability regarding the improper installation or misapplication of its products. It is the BUYER's responsibility to check for proper installation and if

in doubt, contact the manufacturer. The BUYER is solely responsible for all warranty issues from the automotive manufacturer.

The use of this device signifies automatic approval of these conditions.

GALE BANKS ENGINEERING LIMITED WARRANTY

Please see enclosed warranty information card, or go to www.bankspower.com/support/warranty, for warranty information regarding your product. THIS WARRANTY APPLIES ONLY TO THE ORIGINAL CONSUMER PURCHASER OF THIS PRODUCT.

In the event of a defect, GBE will, at its discretion, repair or replace the hardware product with a product of like kind or quality, which may be new or reconditioned, with no charge to the purchaser for parts or labor. GBE's limit of liability under this limited warranty shall be the actual cash value of the product at the time the purchaser returns the product to GBE for repair less a reasonable amount for usage, as determined by GBE in its sole discretion. The repaired or replaced product will be warranted for 90 days from the date of return shipment, or for the balance of the original warranty, whichever is longer.

GBE warrants that the software included in hardware product will be free from defects in the media for a period of 30 days from the date of shipment and will substantially conform to the then current user documentation provided with the hardware products (including updates thereto). GBE's sole obligation shall be the correction or replacement of the media or the software so that it will substantially conform to the then-current user documentation. GBE does not warrant the software will meet purchaser's requirements or that its operation will be uninterrupted, error-free or virus-free. The purchaser assumes the entire risk of using the software.

Disclaimer of Liability & Warranty,

continued

PURCHASER'S EXCLUSIVE REMEDY UNDER THIS WRITTEN WARRANTY OR ANY IMPLIED WARRANTY SHALL BE LIMITED TO THE REPAIR OR REPLACEMENT, AT GBE'S OPTION, OF ANY DEFECTIVE PART OF THE UNIVERSAL iDash OR ACCESSORIES WHICH ARE COVERED BY THIS WARRANTY. REPAIRS UNDER THIS WARRANTY SHALL ONLY BE MADE BY GBE AT ITS FACILITY. ANY REPAIRS BY ANYONE OTHER THAN GBE WILL VOID THIS WARRANTY.

For repair or replacement of the GBE iDash product the purchaser must obtain a Return Materials Authorization (RMA) number from GBE Technical Support, prior to shipping. The purchaser must return the product postpaid with a copy of the original sales receipt, purchaser's return address and the RMA number clearly printed on the outside of the package to the GBE Service Center address provided by GBE with the RMA number. GBE reserves the right to refuse to provide service free-of-charge if the sales receipt is not provided or

if the information contained in it is incomplete or illegible or if the serial number has been altered or removed. GBE will not be responsible for any losses or damage to the product incurred while the product is in transit or is being shipped for repair. Insurance is recommended. GBE recommends the use of a track able shipping method such as UPS or FedEx when returning a product for service.

LIMITATION OF IMPLIED

WARRANTIES. Except as set forth above, all other expressed or implied warranties, including those of fitness for any particular purpose or merchantability, are hereby disclaimed. Some federal, state, or local laws do not allow limitations on implied warranty or on how long an implied warranty lasts, so the above limitation may not apply to you.

EXCLUSIONS. The following are excluded from the warranty coverage:

(a) periodic maintenance and repair or replacement of parts due to normal wear and tear; (b) finishes; (c) installations or defects resulting from installation; (d) any damage caused by (i) shipping, misuse, abuse, negligence, tampering, moisture, Fluids, proximity or exposure to heat, or improper use; (ii) disasters such as fire, flood, wind, and lightning; (iii) unauthorized attachments or modification; (e) service performed or attempted by anyone other than GBE; (g) any product, components or parts not manufactured by GBE; (h) that the receiver will be free from any claim for infringement of any patent, trademark, copyright or other proprietary right, including trade secrets; (f) The opening, dismantling or repairing of this product by anyone other than GBE will void this warranty.

EXCLUSION OF INCIDENTAL OR CONSEQUENTIAL DAMAGES. GBE SHALL NOT BE LIABLE TO PURCHASER OR ANY OTHER PERSON FOR ANY INDIRECT, INCIDENTAL OR CONSEQUENTIAL DAMAGES WHATSOEVER, INCLUDING BUT NOT LIMITED TO LOST PROFITS, DAMAGES ARISING FROM A DELAY OR LOSS OF USE, OR OUT OF THE BREACH OF THIS WARRANTY OR ANY IMPLIED WARRANTY EVEN IF CAUSED BY THE NEGLIGENCE OR ANOTHER FAULT OF GBE OR OUT OF THE NEGLIGENT USAGE OF THE PRODUCT. IN NO EVENT WILL GBE BE HELD RESPONSIBLE FOR SUCH DAMAGES, EVEN IF GBE HAS BEEN ADVISED OF THE POSSIBILITY OF SUCH DAMAGES. Some federal, state, or local laws do not allow the exclusion or limitation of incidental or consequential damages, so the above limitation or exclusion may not apply to you.

This written limited warranty is the complete, final and exclusive agreement between GBE and the purchaser with respect to the quality of performance of the goods and any and all warranties and representations. THIS WARRANTY SETS FORTH ALL OF

Disclaimer of Liability & Warranty,

continued

GBE'S RESPONSIBILITIES REGARDING THIS PRODUCT. THIS WARRANTY GIVES YOU SPECIFIC RIGHTS. YOU MAY HAVE OTHER RIGHTS WHICH VARY FROM LOCALITY TO LOCALITY AND CERTAIN LIMITATIONS CONTAINED IN THIS WARRANTY MAY NOT APPLY TO YOU. If any part of this limited warranty is held to be invalid or unenforceable, the remainder of the limited warranty shall nonetheless remain in full force and effect. This limited warranty is governed by the laws of the State of California, without reference to its conflict of law provisions.

SAFETY INFORMATION

DO NOT USE the iDash NEAR WATER OR IN AN ELECTRICAL STORM AS THIS COULD LEAD TO AN ELECTRICAL SHOCK. DO NOT USE the iDash NEAR A NATURAL GAS LEAK.

Check local regulations for disposal of electronic products.

COPYRIGHT INFORMATION

Products and corporate names appearing in this manual are for identification purposes only. These names may or may not be registered trademarks or copyrights owned by these corporations. Their use by Gale Banks Engineering is for the express purpose of identification or explanation for the owner's benefit and is in no way meant to infringe.

DISCLAIMER

Banks Engineering reserves the right to make improvements, changes or updates to its software at any time without notice. As such the illustrations, images, and descriptions used in this manual may not match exactly the referenced screens as they appear in the latest release of the application.

END USER LICENSE AGREEMENT (EULA)

IMPORTANT! READ CAREFULLY: This End-User License Agreement (“EULA”) is a legal agreement between you (either an individual or a single entity) later referred to as “LICENSEE” and Gale Banks Engineering (hereinafter referred to as “Company” for the software product related to the iDash and Banks AutoMind.

Programmer later referred to as “SOFTWARE”. By installing, copying, or otherwise using the SOFTWARE, you agree to be bound by the terms of this EULA. If you do not agree to the terms of this EULA, do not purchase, install or use the SOFTWARE.

Company or its suppliers may have patents, patent applications, trademarks, copyrights, or other intellectual property rights covering subject matter in this document. The furnishing of this document does not give you any license to these patents, trademarks, copyrights, or other intellectual property.

SOFTWARE LICENSE

Copyright laws and international copyright treaties, as well as other intellectual property laws and treaties protect the SOFTWARE. The SOFTWARE is licensed, not sold.

1. GRANT OF LICENSE.

This EULA grants LICENSEE the following rights:

—LICENSEE may use this SOFTWARE. “Use” of the SOFTWARE means that LICENSEE has loaded, installed, updated and/ or run the SOFTWARE on to a iDash, (latter referred to generally as “devices” or “device”).

—LICENSEE may not simultaneously use the SOFTWARE on more than one device unless they have purchased multiply devices for multiple vehicles.

—LICENSEE may use this SOFTWARE in compliance with all applicable laws and not for any unlawful purpose. - LICENSEE may make a copy of the licensed SOFTWARE for backup purposes.

2. DESCRIPTION OF OTHER RIGHTS AND LIMITATIONS.

—LICENSEE may not reverse engineer, recompile, and disassembly, modify, translate the SOFTWARE and make any attempt to discover the source code of the SOFTWARE.

—LICENSEE may not transfer, sell, re-sell, offer for sale or distribute the SOFTWARE.

The sale of and or distribution of copies of this SOFTWARE are strictly forbidden. It is a violation of this EULA to sell, loan, rent, lease, borrow, or transfer the use of copies of the SOFTWARE unless it is permitted by the terms and/or conditions of a separate agreement signed by Company.

3. DISCLAIMER OF WARRANTY.

THIS SOFTWARE AND THE ACCOMPANYING FILES AND/ OR UPDATES ARE DISTRIBUTED and SOLD “AS IS” AND WITHOUT WARRANTIES AS TO PERFORMANCE OR MERCHANTABILITY OR ANY OTHER WARRANTIES WHETHER EXPRESSED OR IMPLIED. LICENSEE USES THE SOFTWARE AT HIS/HER/ITS OWN RISK.

NO LIABILITY FOR CONSEQUENTIAL DAMAGES. To the maximum extent permitted by applicable law, in no event shall Company or its employees, contractors, agents, distributors or suppliers be liable for any special, incidental, indirect, or consequential damages whatsoever (including, without limitation, damages for loss of business profits, business interruption, loss of business information, loss of data, loss of business opportunity, loss or damages to property, injuries to any person or any pecuniary loss,) arising out of the use of or inability to use the SOFTWARE, even if Company has been advised on the possibility of such damages. In any case, Company’s entire liability under any provision of this EULA shall be limited EXCLUSIVELY TO PRODUCT REPLACEMENT.

4. GOVERNING LAW

This agreement shall be governed by laws of the State of California, U.S.A. applicable therein. You hereby irrevocably and submit to a court of proper jurisdiction in Los Angeles County, California, U.S.A., and any competent Courts of Appeal therefrom. If any provision shall be considered unlawful, void or otherwise unenforceable, then that provision shall be deemed severable from this license and not affect the validity and enforceability of any other provisions. Company reserves all rights not expressly granted here.

ACKNOWLEDGEMENT

By installing, copying, or otherwise using the SOFTWARE, you agree to be bound by the terms of this EULA. If you do not agree to the terms of this EULA, do not purchase, install or use the SOFTWARE.

Section 1:

SAFETY PRECAUTIONS

Always observe safety precautions!

Gale Banks Engineering urges you to always follow safety precautions. These pages include important information intended to prevent personal injury to yourself and/or others, and property damage.

Always be sure you carefully read and under-stand each precaution before moving on to the rest of the manual.

HANDLING PRECAUTIONS

- Never try to disassemble or modify the iDash in any way.
- Do not wipe with a wet cloth.

the iDash contains combustible and metal parts, so water and foreign substances can cause malfunction and create the risk of overheating due to wiring insulation failure, short circuiting, smoke, fire, combustion, and electric shock.

OUTDOOR PRECAUTIONS

When outdoors, avoid using the iDash anywhere it might get wet with rainwater or other moisture, and/or in dusty conditions. the iDash is not water resistant or dust resistant. Water and dust create the risk of fire and smoke, combustion, electric shock, resulting in damage and malfunction.

Never touch the iDash or its electronic accessories with wet hands. This will create the risk of electric shock, short circuiting or insulation failure, fire, smoke and combustion. Also, never allow the connector plugs to become wet.

Keep micro-SD cards out of the reach of small children as they may be swallowed. If you think this might have happened, Call 911 or consult your local emergency services (police, fire, or ambulance) immediately.

Do not touch the iDash or its OBDII cable if there is lightning in your area.

Lightning strikes create the risk of electric shock.

IN-VEHICLE PRECAUTIONS

Use this unit in 12V DC negative ground vehicles only.

WARNING: Below 32° F (0° C) or above 140° F (60° C), the iDash may be susceptible to damage as a result of extended direct exposure to sunlight, heat, or extreme cold. If the vehicle will be subjected to these conditions, we highly recommend that you remove the iDash from its mounting location. Gale Banks Engineering is not responsible for damage to the iDash resulting from exposure conditions.

Always drive in accordance with traffic rules and regulations. Failure to do so may result in traffic accident and injury to yourself and/or others.

Never take your eyes off the road to adjust the iDash settings or change screens while driving vehicle. Doing so can result in a traffic accident. Always stop your vehicle in a safe place before operating the unit. Only look briefly at the iDash screen images while operating your vehicle. Doing otherwise can take your mind off the road and create the risk of a traffic accident and injury to yourself and/or others. Do not set volume level too high. Blocking out the sound of other vehicles and traffic can create the risk of a traffic accident.

Never install the iDash in a location where it will interfere with operation of the motor vehicle, block the driver's view, or where it may endanger passengers. Installing the unit near the shift lever, brake pedals or other vehicle controls, or block front, side or rear vision, can create the risk of a traffic accident and cause injury to yourself and/or others. Never install the iDash where it can interfere with airbag operation. Do not install in a

SAFETY PRECAUTIONS, *continued*

location where deployment of the airbag cause the iDash or its parts to become projectiles. Also, be sure to check installation precautions for your exact vehicle model and year.

Make sure to install the iDash mount so it does not come off or fall down. Clean off any dirt and wax from the installation location, and install securely.

Periodically check the iDash mount installation and condition of the cradle.

PRECAUTIONS FOR USE IN VEHICLE

Use only the items that come with this unit and the Banks products it was designed to interface with. Use of non-specified items can damage the vehicle interior or result in a poor fit, creating the risk of accident, malfunction, or fire.

Install the iDash where it is out of the reach of small children. Failure to do so can cause an injury to the child or others due to mishandling of the iDash.

Do not install the iDash in a location where it will be splashed by water or subjected to large amounts of humidity, dust, or oil smoke. This can increase the risk of smoke, combustion, electric shock, and accident.

PRECAUTIONS DURING USE

- To protect the Liquid Crystal Display (LCD), avoid exposure to direct sunlight while not in use. Using a car sunshade or other means to block the sun is recommended.
- Do not clean the iDash while power is turned on. When wiping the LCD, use a dry soft, micro-fiber cleaning cloth.
- Do not use a paper towel to clean the screen.
- When transporting the iDash, make sure that the LCD screen does not come in contact with any foreign objects.

Precautions during use inside a motor vehicle: Always be sure to use the iDash in accordance with local rules and regulations.

Section 2: MOUNTING AND CONNECTING THE iDash

2.1 Basic Setup

1. Mounting the iDash requires a mount suitable for 52mm / 2 1/16" gauges. An optional window mount assembly can be purchased from Banks Power.
2. Insert the iDash into the mount and secure using the mount sleeve and thumb nuts supplied. See **Figure 1**.

Figure 1

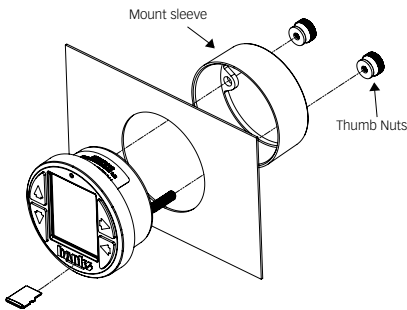

3. Locate the OBDII connection port in your vehicle. The OBDII connection port is located under the dash panel and can be located on either side of the steering wheel. Refer to your vehicles owner's manual if you are having difficulty locating the OBDII port. See **Figure 2**.

Figure 2



4. Locate the Banks OBDII Cable (See **Figure 3**) and connect the Banks OBDII connector to the vehicle's OBDII port. See **Figure 4**.

NOTE: For some vehicle models the OBDII connection port may need to be disconnected from its mounting location. Unclip or remove factory screws/bolts to relocate the OBDII connection port and allow the Banks OBDII connector to plug into the vehicles OBDII connector without bending or putting stress on the Banks OBDII cable. Secure the OBDII connection port under the dash.

Figure 3 - BANKS OBDII Cable

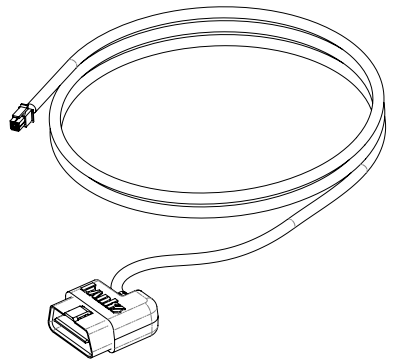

Figure 4



MOUNTING AND CONNECTING THE iDash, *continued*

5. Determine a suitable location for the mount that provides ease of access and viewing of the iDash.

6. Route the Banks OBDII Interface Cable to reach the iDash.

NOTE: *You may need to loosen or remove dash panel or covers to install the interface cable between dash crevices or behind dash panels.*

7. Connect the Banks OBDII Cable to the 4-pin connector on the rear of the iDash. See **Figure 5**.

8. Secure the mount in the selected location. If using a suction cup mount make sure the suction cup and the mounting area on the windshield are clean and dry then secure in place.

9. Secure the Banks OBDII Cable away from any moving parts or sharp edges using the supplied cable ties. Be sure to check the operation of all pedals and steering and adjust the steering wheel tilt and adjustable pedal location, if equipped, to ensure proper function and clearance with the added OBDII Cable.

NOTE: *The iDash is “live” as long as the Banks OBDII interface cable is completely installed and the OBDII Cable 4-pin connector is plugged into the back of the iDash.*

Figure 5



MOUNTING AND CONNECTING THE iDash, *continued*

2.2 Daisy Chain

If you want more iDash units, you can "daisy chain" up to 3 additional iDash units. See **Figure 6**.

1. If the first iDash (Primary) is not yet connected, follow the sequence in 2.1 Basic Setup to start a "daisy chain."
2. Start with the first iDash or Primary of the "daisy chain." Using the 6-pin Y-Adapter and a 6-pin In-Cab Terminator, connect the Primary to the second iDash (Secondary).
3. Use the 6-pin Y-Adapters to "daisy chain" up to 2 additional iDash units.

4. Once all the iDash Units are connected, the OBDII system can be powered on.

Note: Only the Primary is capable of some features such as:

- Vehicle Diagnostics (reading/clearing codes, Emissions Readiness)
- Setting wakeup sensitivity
- Data logging
- Speed correction settings
- More

Figure 6 – Daisy Chain

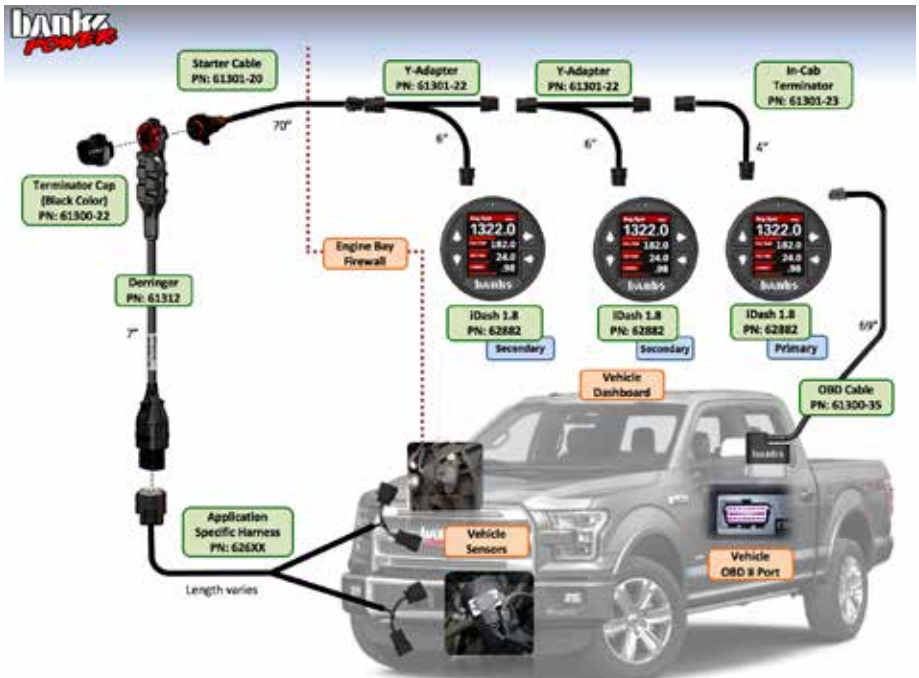

Section 3:

SOFTWARE INTRODUCTION AND NAVIGATION

NOTE It is recommended that you periodically check for software update for best performance of your iDash.

Obtain update software at web.bankspower.com/update/

Register at www.bankspower.com/contact/productregistration to receive important e-mail alerts regarding updates and upgrades for your iDash device. Or call us with questions at 1-800-438-7693.

3.1 First start

Once the iDash is properly connected to the vehicle (Section 2), it will wake up and be ready for use when the vehicle engine is started.

The first time the gauge is powered on it will instruct you to input your engines displacement in liters or in cubic inch units. This is used in calculated parameters such as CFM Engine. This can be changed at any time (see sec 11.9)

The iDash will display the "Gauge Screen" unless or until you select a different menu. When navigating through menus, the iDash will automatically return to the "Gauge Screen" after one (1) minute of inactivity. See **Figure 7**.

Figure 7 – Start Up ("Gauge Screen")



Section 3: SOFTWARE INTRODUCTION AND NAVIGATION, *continued*

The iDash comes pre-programmed on the "Gauge Screen" to display only two (2) of the five (5) total available parameter displays shown in **Figure 7** until the user sets up their preferred "Gauge Screen" display in the layout menu in **Section 4**.

3.2 Sleep Mode/Wake up



When the iDash is connected to your vehicle it will go into "Sleep Mode" ten (10) seconds after the vehicle is turned off.

There is no need to exit the iDash application or unplug the iDash. The iDash will automatically "wake up" when the vehicle ignition is turned on and stay on after the engine is started.

It is possible to wake up the iDash while the key is on by pressing any of the four (4) buttons, but it will only stay on for thirty (30) seconds and return to sleep if it does not see engine RPM.

3.3 Button Navigation

Press  (forward/select) to enter menus or select an item. Holding down the button saves the current selection and returns to the "Gauge Screen."

Use  (up) or  (down) to scroll through selections or raise and lower values. Hold down the button for rapid scroll/value change. While viewing the "Gauge Screen," holding down  for two (2) seconds also starts and stops data logging.

A single press of  (back/exit) returns you to the previous menu/screen. Depressing and holding down the button will return the device to the "Gauge Screen." The back button will also turn the button lights on or off when in the "Gauge Screen." When in data log menu, the back button can be used to set lap or trigger points in a data log session. See **Figure 8**.

Note: If you are using the iDash 1.8 without OBD2 data using ignition switch 12v. See section 10.11

Figure 8 – Button Function.

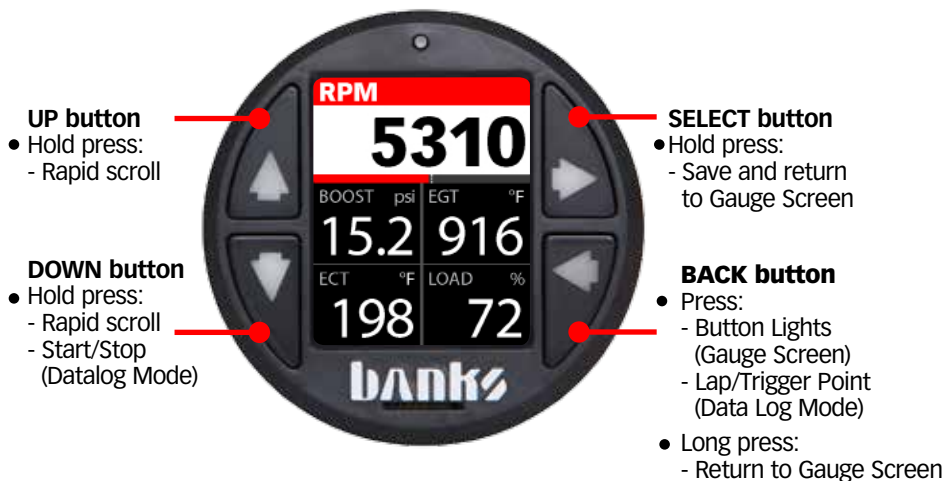

IDASH MENU TREE

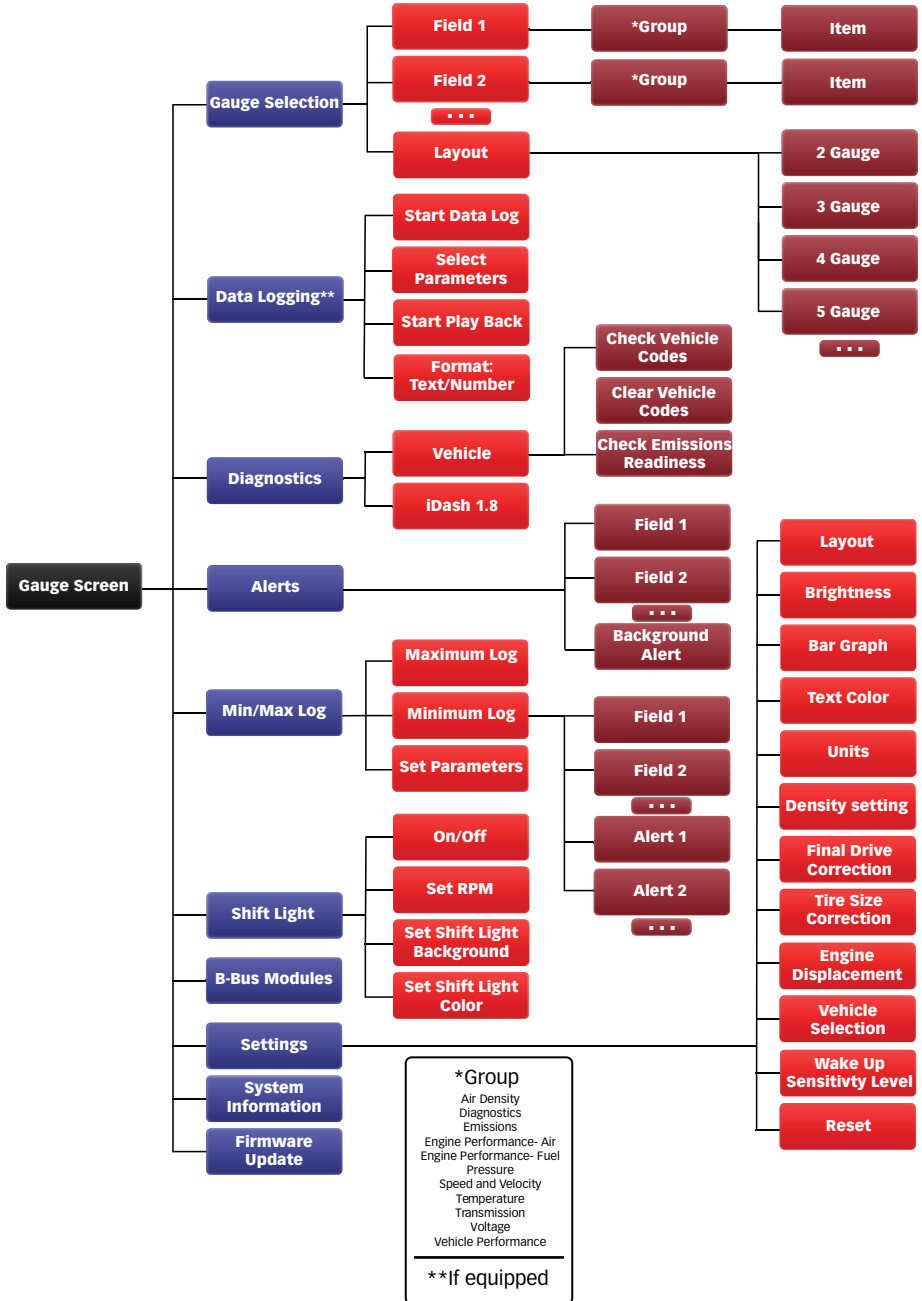

Section 4:

GAUGE SELECTION

The gauge selection menu allows quick access to select the screen layout along with the parameter you want to view in each gauge location.

4.1 Layout

This menu allows you to set up the layout of the display. The user can select the number of parameters to display or other special Banks layout screens, if available.

4.1.1 Number of Gauges

To modify the number of gauges displayed:

1. Select "**Gauge Selection**" from the main menu then select "**Layout.**"
2. Select the desired layout, ranging from 2-5 gauges. You will automatically be returned to the "**Gauge Screen.**"

4.1.2 Density Layout

A detailed explanation of the Banks Density system is available in the glossary (sec 14.1).

To select the Density layout:

1. Select "**Gauge Selection**" from the main menu then select "**Layout.**"
2. Select the "**Density**" layout. You will automatically be returned to the "**Gauge Screen.**" The Density layout will display preconfigured parameters.

Note: Density is calculated from vehicle data sensors and will only be available if your vehicle is equipped with the proper sensors. Ambient Air Density (AAD) requires that your vehicle be equipped with an Ambient Air Pressure (AAP) and Ambient Air Temperature (AAT) sensor. Manifold Air Density (MAD) requires that

you vehicle be equipped with a Manifold Absolute Pressure (MAP) and a Manifold Air Temperature (MAT) sensor. Boost Air Density (BAD) requires that all 4 sensor are equipped. Most modern vehicle have these sensor but if they are not available or if you want more precise and faster responding Density data you can install the Banks Ambient Air Density Module, and Banks Density Module.

Note: If your vehicle is equipped with the proper parameters, the layout will be set up as shown in **Figure 9**. In this layout, only the bottom three can be changed with user selectable parameters.

3. Field one of this layout is configured to only display MAD or BAD. Press the select button on Field one to switch between these options.

Note: When displaying MAD, the yellow dotted line on the bar graph indicates your current AAD. The blue section of the bar graph represents the current BAD.

4. Press select on "Density Standard:" to change between J1349 and J607 as the standard day reference. See Density section of the glossary for more details

5. Press select on "Density Unit:" to change between displaying field one in lbs/1000ft³ or as % of standard day.

6. Press select on "Density Scale:" to change the scaling of the bar graph. Options are 125, 200, 300, 400 and 500

Section 4: **GAUGE SELECTION, *continued***

Figure 9 – Density Layout



Section 5:

DATA LOGGING (IF EQUIPPED)

Figure 10 – Data Logging Menu



Data logging saves (*.CSV files) to the Micro SD card. The card must be inserted into the slot in the iDash for data logging to function. Each time the data logging function is turned off, a new CSV file containing the recorded data will be saved onto the Micro SD card. Up to 100 parameters can be recorded at the same time but as the number of recorded channels is increased, the recording rate will decrease, so only record the parameters you need.

Note: Data logging is only available on the primary gauge. If you have multiple gauges, only one of them needs to be a data logging equipped gauge.

5.1 Start/Stop Data Log

To start or stop a data log:

1. Select "**Data Logging**" from the main menu.
2. Select "**Start Datalog**" to start recording parameters.

Note: A Micro SD card must be inserted into the card slot on the front face of the iDash in order for data logging to begin. If no card is inserted, the device will display "**SD card is Not Ready.**"

3. Data logging can be stopped by selecting "**Stop Datalog.**"

4. When viewing the "**Gauge Screen,**" a green dot at the top of the display will flash indicating the logging is on. When logging is turned off, this dot will not appear.

Note: Logged data will have 1 more digit than displayed, i.e., MAP 15.1 is displayed, but MAP 15.13 will be logged.

5. Logging can also be turned "**On**" and "**Off**" by holding down the down button when viewing the "**Gauge Screen.**"

5.2 Change Parameters to be Data Logged

1. Select "**Data Logging**" from the main menu.

2. To set which vehicle parameters to record, select "**Select Parameters for Datalog.**"

3. The parameters displayed are the parameters that will be recorded when using data logging. To add parameters to be recorded, select "**ADD BIDs.**"

Note: The gauge ships with a preconfigured list of common parameters set up for data logging.

4. Select a parameter group.

5. Select a parameter to add it to the recording list. The parameter will be highlighted once it is selected. You can select multiple parameters at a time.

Section 5:

DATA LOGGING (IF EQUIPPED), *continued*

Once all desired parameters from this group have been selected, return to the parameter group screen. Repeat this process for all the parameter groups until all desired parameters have been selected.

6. Return to the **"Datalog Screen."** This list will now include all the new parameters added.

7. If you wish to remove a parameter from the list for data logging, simply select a parameter and it will no longer be highlighted. This parameter will not be recorded and will be removed from the list once you exit the screen.

8. Once the parameter list for data logging is as desired, return to the **"Gauge Screen."**

5.3 Format

The recorded data can be saved as **"Text"** or **"Number."** In **"Number"** format, status like **"On"** or **"Off"** will be recorded as numbers rather than text. This can be useful when graphing data but requires the user to know what these numbers indicate. If the data will not be graphed, text is usually the preferred format.

Note: *The format can only be changed before the data is recorded and cannot be changed later.*

1. Select **"Data Logging"** from the main menu.
2. To change the format of the data to be saved, select **"Format"** to switch between **"Text"** and **"Number."**
3. Return to the **"Gauge Screen"** when finished.

5.4 Data Play Back on Gauge

1. Select **"Data Logging"** from the main menu.
2. Select **"Start Play back"** to open the list of data logs.
3. Select the desired log for play back, and the data will begin playing on the iDash display. The blinking blue box at the top indicates that playback is active.

Note: *Only parameters that were recorded on the log will be able to be shown. If a parameter shows "--" it was most likely not configured as a logged parameter at the time of the data log recording.*

4. Time can be added to any field by selecting the **"diagnostics"** group then the **"Time Data Log"** parameter.
5. At any time, the primary or any secondary gauges can be reconfigured to display any of the recorded parameters.

Note: *When in normal playback mode, pressing the up or down buttons will skip ahead or back by 5 seconds. Holding the up or down buttons will skip 30 seconds ahead or back.*

6. To pause data play back, press the back arrow on the iDash gauge.

To resume data play back, press the back arrow a second time.

Note: *While data playback is paused, pressing the up or down buttons will move ahead or back one line of data per press (0.1 seconds). Holding the up or down buttons will skip 5 seconds at a time.*

Section 6: DIAGNOSTICS

6.1 Vehicle Diagnostics - Trouble Codes

See the cause of your vehicle's "check engine" light! With the iDash, you can read and clear vehicle manufacturer trouble codes.

1. Select "**Diagnostics**" from the main menu.
2. Select "**Vehicle**" for vehicle diagnostics.

Note: *Vehicle must be stopped to access vehicle diagnostics.*

3. Select "**Check Vehicle Codes**" to read vehicle trouble codes. If vehicle codes are present, a list will appear below as shown in **Figure 11**. Note trouble code number and description before clearing.

4. Select "**Clear Vehicle Codes**" to erase vehicle trouble codes. Trouble codes and/or check engine light may recur if the cause of the code is not repaired prior to clearing codes.

5. Return to the "**Gauge Screen**" when finished.

Note: *Some vehicle require that the engine be turned off to clear codes. Follow message prompts if your vehicle has this requirement.*

Figure 11 – Check Vehicle Codes



Section 6: **DIAGNOSTICS**, *continued*

6.2 Vehicle Diagnostics - Emissions Readiness

Check your vehicle's emissions readiness to test and see whether or not your vehicle's emission system is operating normally.

1. Select "**Diagnostics**" from the main menu.
2. Select "**Vehicle**" for vehicle diagnostics.
3. Select "**Check Emission Readiness**" for a list of supported emissions monitors. A "**YES**" indicates that the monitor has passed its test and the system is operating correctly. A "**NO**" indicates that the monitor has either failed the test or that the test has not completed. See **Figure 12**.
4. Scroll through the list of monitors and return to the "**Gauge Screen**" when finished.

Note: *The following may reset your monitors:*

- *Clearing diagnostic trouble codes*
- *Loss of power to the vehicle by a dead or disconnected battery*

Figure 12 – Emissions Monitors



Section 7: ALERTS

Custom gauge warnings used to notify the operator that a displayed or background parameter has exceeded its limit. These alert limits can be viewed and changed by following the process below:

Figure 16 – Alerts Menu



7.1 Displayed Gauge Alerts

1. Select "**Settings**" from the main menu and then select "**Alerts.**"
2. Select the parameter you wish to view or adjust the alert for.
3. Select "**Alert High Enable**" or "**Alert Low Enable**" to activate or deactivate the alert.
4. Adjust the alert activation point for either "**Alert High**" or "**Alert Low**" by selecting the alert you wish to adjust.
5. Adjust the activation point and save the setting.
6. Return to the "**Gauge Screen**" when finished.

7.2 Background Alerts

Additionally, gauge warnings can be set for a selection of background

parameters using the following steps. Background alerts are for a list of predefined parameters that are constantly being monitored by the iDash, even when they are not being displayed on a gauge. These alerts can be set to warn the user if any of the parameters exceed the alert set point defined by the user.

1. Select "**Settings**" from the main menu and then select "**Alerts.**"
2. Select "**Background Alerts.**"
3. Select an empty alert to add a new alert.
4. Select a parameter group.
5. Select a parameter to add it to the alerts.
6. Set desired limits by selecting "**Set Limit**" and return to the background alert screen.
7. Repeat this process to add desired background alerts. You may also change any existing alerts by selecting an alert with an assigned parameter and then selecting "**Change Parameter.**"
8. If you wish to remove a parameter from background alerts, select an existing alert and then select "**Remove Parameter.**"
9. Once the background alerts is as desired, return to the "**Gauge Screen.**"

Note: *The alerts in the "Min/Max Values" are linked to the "Background Alerts" in "Settings." Adding, removing, or changing these alerts in one menu will change the alerts in the other.*

Section 8: MIN/MAX VALUES

Your device keeps a constantly updated record of key parameter minimum/maximum values for you to view or reset at your convenience.

1. Select "**Min/Max Values**" from the main menu.
2. Select either "**Maximum Values**" or "**Minimum Values**" to access either the recorded parameter minimum or maximum values.
3. The screen will display the min/max values for a predefined list of parameters. See **Figure 13**.
4. If you'd like to reset all current min/max values to zero, select "**CLEAR ALL**."
5. Return to the "**Gauge Screen**" when finished.

Note: The alerts in the "Min/Max Values" are linked to the "Background Alerts" in "Settings." Adding, removing, or changing these alerts in one menu will change the alerts in the other.

Note: Some vehicles report a very large value for an instant during vehicle power down. This might cause an inaccurate maximum log.

Figure 13 – Maximum Values



Section 9: SHIFT LIGHT

The iDash features a custom shift light for you to set to any desired RPM.

1. Select **"Shift Light"** from the main menu.

2. The first item in the will display **"On"** or **"Off."** This indicates if the shift light is active. If **"Off"** is displayed, the shift light will not function. To change the status of the shift light, select **"On"** or **"Off."** See **Figure 14.**

3. Select **"Set RPM"** to adjust the RPM set point at which the shift light will illuminate. The set point can be adjusted in increments of 100 RPM until the desired value is displayed.

Note: *Due to data delay of vehicle OBDII communication, you may need to set your shift light RPM lower than your desired shift point.*

4. Select **"Set Shift Light Font Color"** and/or **"Set Shift Light Background Color"** to customize the look of your shift light.

5. Scroll through the list and select a color.

6. Return to the **"Gauge Screen"** when finished.

Figure 14 – Shift Light Menu



Figure 15 – Shift Light



Section 10:

B-BUS MODULES

"B-Bus Modules" is where you can configure and setup various Sensor and Control modules that are on the system. Only connected Banks modules will show up in this section.

10.1 Banks Derringer Tuner

- 1.** Select "B-Bus Modules" from the main menu
- 2.** Select "Derringer"
- 3.** "Power Level" will be shown with the current setting. Press the select button to change the power button.

Modules coming soon are:

Banks Ambient Air Density Module

Banks 4 channel input module

Banks 4 channel EGT module

Banks Wideband Oxygen Sensor module

Banks Frequency Module

Banks Water Methanol Module

Banks Nitrous Control Module

Banks Boost Control Module

Banks Relay control

More to be announced...

Section 11: SETTINGS

The iDash features many customizable features from the amount of gauges displayed on screen to custom gauge alert set points to separate button and screen brightness.

11.1 Layout

This menu allows you to set up the number of gauges or Banks device(s) control scheme(s) to display.

1. Select "**Settings**" from the main menu.
2. Select "**Layout.**"
3. To select the number of parameters to display or the Banks device(s) control scheme(s) to display, select the desired layout. You will return to the "**Gauge Screen.**"

Note: *This setting is also available in the "Gauge Selection" menu.*

11.2 Brightness

Customizing the brightness of your device buttons and LCD screen is made easy. There is even an "Auto-Dimming" feature that senses the ambient light conditions and adjusts the brightness for brighter and darker conditions. To adjust brightness of the display or buttons:

11.2.1 Auto-Dimming

"Auto-Dimming" can be configured to automatically adjust screen brightness for darker or brighter conditions. To utilize this feature, the "Auto-Dimming" must be "On."

If you do not desire to use this feature and want the screen to utilize a constant brightness no matter what the ambient light conditions are, set the "Auto-Dimming" to "Off." Turn "Auto-Dimming" "Off" and then skip ahead to the "Button Lighting" and "LCD Backlight" adjustment sections below.

Use the following sequence to turn "Auto-Dimming" "On" or "Off."

1. Select "**Settings**" from the main menu and then select "Brightness."
2. Select "**Auto-Dimming**" to toggle on or off. Different settings will appear below depending on the status of "**Auto-Dimming.**"

11.2.2 LCD Lower Limit

The brightness of the display in darker conditions.

1. Select "**Settings**" from the main menu and then select "Brightness."
2. Select "**LCD Lower Limit.**"
3. Adjust the LCD screen brightness for dark conditions.
4. Save the LCD lower limit setting.
5. Return to the "**Gauge Screen**" when finished.

11.2.3 LCD Upper Limit

The brightness setting of the display in brighter conditions.

1. Select "**Settings**" from the main menu and then select "**Brightness.**"
2. Select "**LCD Upper Limit.**"
3. Adjust the LCD screen brightness

Section 11: **SETTINGS**, *continued*

for bright conditions.

4. Save the LCD upper limit setting.
5. Return to the "**Gauge Screen**" when finished.

11.2.4 Button Lower Limit

1. Select "**Settings**" from the main menu and then select "**Brightness.**"
2. Select "**Button Lower Limit.**"
3. Adjust the button brightness for dark conditions.
4. Save the lower limit setting.
5. Return to the "**Gauge Screen**" when finished.

11.2.5 Sensitivity Level

This controls how sensitive the iDash device is to changes in ambient light.

Note: *If the sensitivity level is set to high, the display brightness will change often and can be distracting. If this occurs, lower the sensitivity level.*

1. Select "**Settings**" from the main menu and then select "**Brightness.**"
2. Select "**Sensitivity Level.**"
3. Adjust the sensitivity level.
4. Save the sensitivity level setting.
5. Return to the "**Gauge Screen**" when finished.

11.2.6 Button Lighting

Use the following sequence to adjust the brightness of the iDash LCD buttons when "**Auto-Dimming**" is "**off**":

1. Select "**Settings**" from the main menu and then select "Brightness."
2. Select "**Button Lighting.**"
3. Adjust the button lighting brightness. The higher the number, the brighter the button lighting will be.
4. Save the setting.
5. Return to the "**Gauge Screen**" when finished.

11.2.7 LCD Backlight

Use the following sequence to adjust the brightness of the iDash LCD screen when "**Auto-Dimming**" is "**Off**":

1. Select "**Settings**" from the main menu and then select "**Brightness.**"
2. Select "**LCD Backlight.**"
3. Adjust the screen brightness. The higher the number, the brighter the screen lighting will be.
4. Save the setting.
5. Return to the "**Gauge Screen**" when finished.

11.3 Bar Graph

A bar graph representation of your parameter values in the gauge screen.

Figure 17 – Bar Graph Menu



Section 11: **SETTINGS**, *continued*

11.3.1 Enable/Disable Bar Graph

To enable or disable the bar graphs below each parameter:

1. Select "**Settings**" from the main menu and then select "**Bar Graph.**"
2. Select "**Bar Graph: Enable**" or "**Bar Graph: Disable**" to toggle the bar graphs on or off.
3. Return to the "**Gauge Screen**" when finished.

11.3.2 Bar Graph Color

To change the color of the bar graphs:

1. Select "**Settings**" from the main menu and then select "Bar Graph."
2. To change the color of the bar graphs, select "**Bar Graph Color**" to enter the color selection screen and then select a bar graph color. You will be returned to the previous screen.
3. Return to the "**Gauge Screen**" when finished.

11.3.3 Bar Graph Limits

To set the lower and upper limits of the bar graph:

1. Select "**Settings**" from the main menu and then select "**Bar Graph.**"
2. Select a "**Limit Field**" or parameter to customize.
3. Select "**Bargraph Min**" or "**Bargraph Max**" and adjust the limit.
4. Save the setting.
5. Repeat this process for any other parameters as desired.

6. Return to the "**Gauge Screen**" when finished.

11.4 Text Color

Customize the look of your gauge display by selecting from one of 23 different text colors.

1. Select "**Settings**" from the main menu.
2. Select "**Text Color**" to enter the color selection menu.
3. Select a text color.
4. Return to the "**Gauge Screen**" when finished.

11.5 Units

Choose to display your preferred units for parameter values.

11.5.1 U.S./Metric

This function allows you to select whether to view parameter information in either U.S. or Metric units. Note: This does not affect pressure parameters. The units for pressure parameters are set using the "Pressure Standard" menu described below.

1. Select "**Settings**" from the main menu then select "**Units.**"
2. Select "**U.S./ Metric.**"
3. Select your display unit preference.
4. Return to the "**Gauge Screen**" when finished.

Section 11:

SETTINGS, *continued*

11.5.2 Pressure Standard

Depending on your preference, you can display pressure values in either Pounds per Square Inch, Bar, or Kilopascals.

1. Select "**Settings**" from the main menu then select "**Units.**"
2. Select "**Pressure Standard.**"
3. Select your pressure unit preference.
4. Return to the "**Gauge Screen**" when finished.

11.6 Density Settings

Adjust/compare data to either SAE J607 or J1349 standards for ambient conditions. These two standards are commonly used with dynamometers to adjust to SAE standard day conditions for comparable power numbers in varying weather conditions:

1. Select "**Settings**" from the main menu.
2. Select "**Density Setting.**"
3. The highlighted standard is what will be used for determining a density standard. Select your density standard preference.
4. Return to the "**Gauge Screen**" when finished.

11.7 Tire Size Correction

This feature will correct the displayed vehicle speed for vehicles with tires that are different from the manufacturer's specification.

1. Select "**Settings**" from the main menu.
2. Select "**Tire Size Correction.**"
3. Choose to enable the speed correction feature.
4. Input the vehicle's stock tire size
5. Input the current tire size
6. The vehicle speed displayed on the iDash will now be correct for the current tire size on the vehicle.

Note: *This will only correct the iDash 1.8 speed reading, it will not correct your vehicles instrument cluster speedometer.*

11.8 Final Drive correction

This will correct the displayed vehicle speed for vehicles with final drive ratios that are different from what the vehicle was originally equipped with.

1. Select "**Settings**" from the main menu.
2. Select "**Final Drive Correction.**"
3. Choose to enable the final drive correction features.
4. Input the vehicle's stock final drive ratio.
5. Input the current final drive ratio.

Note: *It will not correct your vehicles instrument cluster speedometer.*

Section 11:

SETTINGS, *continued*

11.9 Engine Displacement

Engine displacement is required to calculate the volume of air being pumped through the engine (CFM). It is also necessary to calculate Cylinder Head Efficiency.

1. Select "**Settings**" from the main menu.
2. Select "**Engine Displacement.**"
3. You can input engine size in either Liters or by Cubic inch displacement.
4. Use the Up and Down buttons to change engine displacement. Once the displacement is correct, press the Right button to save the engine displacement.

11.10 Vehicle Selection

If you are using the iDash 1.8 with Banks Sensor and control modules only and are not using OBD2 data, select the "No OBD" option from vehicle selection.

This mode does not use RPM check for waking up. You must use an ignition switched 12v source for power.

1. Select "**Settings**" from the main menu.
2. Select "**Vehicle Selection.**"
3. Select the vehicle the iDash is connected to. *Note: If your vehicle is not displayed in this listing, it is not required that you select a vehicle. Highlight "**Standard**" at the top of the screen in this case.*
4. Enjoy the additional parameters. The iDash will reboot and return to the "**Gauge Screen.**"

11.11 Wakeup Sensitivity Level

This feature helps with OnStar and other automatic diagnostic systems in your vehicle. For additional assistance, contact Banks Tech Support.

1. Select "**Settings**" from the main menu.
2. Select "**Wakeup Sensitivity Level.**"
3. Select the desired sensitivity level.

Note: *If the gauge is interfering with OnStar or other similar services, decrease the sensitivity one level lower.*

4. Return to the "**Gauge Screen**" when finished.

11.12 Reset

1. Select "**Settings**" from the main menu.
2. Select "**Calibrate Ambient Sensor**" or "**Reset All Settings**" to either recalibrate the light sensor or reset iDash to factory settings.
3. Return to the when finished. The iDash will reboot and return to the "**Gauge Screen**" if reset.

Section 12:

SYSTEM INFORMATION

This menu displays information regarding the Banks hardware and software of the iDash and any Banks device connected to it. Please include this information when requesting Banks Tech Support for your device.

1. Select "**System Information**" from the main menu.
2. Select the desired Banks device.
3. The system information will be displayed as shown in **Figure 19**. This is the information that will need to be supplied to Banks Tech Support if requested.
4. Return to the "**Gauge Screen**" when finished.

Figure 18 – System Information



Section 13: FIRMWARE UPDATE

As new Banks firmware becomes available, you can update your iDash and any connected devices by loading the update onto a Micro SD card and inserting it into the Micro SD card slot (see **Figure 20**) on your device. Visit web.bankspower.com/update/ to download the most current firmware.

1. Download latest firmware files from Bankspower website.
2. Transfer firmware files to the Micro SD card using a computer.

Note: microSD card not included in base gauge. Any microSD card (16GB to 32GB) will work.

3. Insert Micro SD card into the Micro SD card slot on the iDash.
4. Select "**Firmware Updates**" from the main menu.
5. Select the desired Banks device.
6. Select the appropriate firmware

update to install it. The iDash will reboot and return to the "**Gauge Screen**."

7. Do not remove Micro SD card until you see the "**Firmware Update Success**" pop-up.

Caution: Be careful when moving or using the iDash while a Micro SD card is inserted. Provide a minimum clearance of at least 9 mm for the Micro SD card as shown in **Figure 21** to avoid breakage.

Figure 20– Minimum Clearance for Micro SD Card

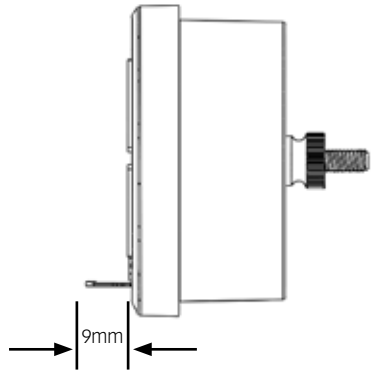

Figure 19 – Micro SD Card Slot



Section 14:

GLOSSARY

14.1 Banks Engine Air Density System Overview

Horsepower is directly dependent on the number of oxygen molecules available for combustion. Simply put, the more oxygen your engine has, the more fuel it can combust and the more Horsepower it can make. Boost pressure has been the go to performance measurement to predict Horsepower changes because it directly affects the amount of oxygen available to the engine. However, it is only part of the story and leaves out the temperature effects on oxygen content which is a critical element that can greatly alter your engines Horsepower.

So if Boost isn't the best performance indicator, what is? Air Density is the most direct measurement of oxygen molecule being used by your engine for combustion. Unlike looking simply at Boost pressure, it accounts for the effect that temperature plays on oxygen content of the air. Density is defined as lbs. mass of air per ft³ of volume. We display this parameter as lbs./1000ft³ which scales it to an easier to read range of typically 0-300.

Because the air density changes based on pressure, temperature and humidity, the power output of your engine will also change based on your current ambient conditions. The Society of Automotive Engineers (SAE) has defined a set of ambient conditions that all engines must be corrected to when measuring Horsepower. SAE J1349, which is the most common correction factor, uses an ambient pressure of 14.4 psia, ambient temperature of 77 deg F and a relative humidity of 0%, which results of an ambient air density of 72.2 lbs./1000 ft³. Another common density standard is SAE J607 which has an ambient air density of 76.4 lbs./1000ft³.

All Banks density measurements can be viewed in its raw value form, or normalized against a selectable standard day and read as a percentage. This makes it quicker to compare to standard conditions. If Ambient Air Density (AAD) is over 100% then there is more oxygen per unit volume in the air and if it is below 100% then there is less oxygen content then the J1349 standard day.

Manifold Air Density (MAD) is calculated just like AAD except it uses the Manifold Absolute Pressure and Manifold Air Temperature data. This reading represents the mass of oxygen per unit volume available in the manifold. Boost Air Density (BAD) is another useful measurement which is calculated as MAD – AAD. It is the additional Density available in the manifold greater than the current ambient conditions and is a more insightful performance measurement then simply using Boost pressure.

Note: U.S. Patent 7,254,477 B1 U.S. Patent 7,593,808 B2 apply to this product.

Section 14: GLOSSARY

14.2 Data Definitions

Note: The following list of data parameters is not a comprehensive list of everything that the iDash can display. It is a smaller subset of some of the more common and useful parameters that you may want to monitor on your vehicle.

The parameters available on your iDash is dependent on what sensors the manufacture has installed on your vehicle. You will not be able to see every data listed in the glossary due to it not being supported by your vehicle.











Data is organized in groups or categories to be able to easily locate the parameter you are interested in.

Some vehicle will have multiple sensors in a system (ex: EGT1/1, EGT1/2, EGT1/3...). In these instances Bank 1 refers to the side of the engine that the number 1 cylinder resides as defined by the manufacturer. Bank 2 is most commonly only found in "V" configuration engines and it indicates the side of the engine opposite of the number 1 cylinder. When there are multiple sensors measuring the same type of data in a system (ex: IAT1, IAT2, IAT3...) then the number 1 sensor is located furthest upstream in the path of airflow and the highest number sensor available is furthest downstream in the system.

An "*" at the end of the acronym indicates that the data is from Banks Modules and not from the OBDII port (ex: RH* or Relative Humidity is obtained from the Banks Ambient Density Module).

AIR DENSITY (Banks Patented) (Banks Exclusive)

Abbreviation Parameter Name

- AAD **Ambient Air Density**  - Mass of air per volume of the air surrounding the vehicle.
- BAD..... **Boost Air Density**  - Mass of air per volume in intake manifold greater than the Ambient Air Density.
- MAD..... % **Manifold Air Density**  - Manifold Air Density expressed as a percentage of the selected standard day.
- AAD % **Ambient Air Density**  - Ambient Air Density expressed as a percentage of the selected standard day.
- BAD..... % **Boost Air Density**  - Boost Air Density expressed as a percentage of the selected standard day.
- DCF..... **Density Correction Factor**  - Ratio of actual ambient air density to selected standard day.
- D-RAT..... **Density Ratio**  - Ratio of Manifold air Density compared to Ambient Air Density.
- MAD..... **Manifold Air Density**  - Mass of air per volume in the intake manifold.
- MAN RH **Manifold Relative Humidity**  - Relative humidity in the intake manifold, a value greater than 100% indicated condensation).
- RH* **Relative Humidity (B-Bus)**  - Percentage of water vapor in ambient air compared to maximum potential water vapor.

Section 14:

GLOSSARY, *continued*

Data Definitions, *continued*

DIAGNOSTICS

<u>Abbreviation</u>	<u>Parameter Name</u>
---------------------	-----------------------

MIL.....	MIL Status - Status of the malfunction indicator lamp (or CEL).
DTCCLR.....	Run Time Since DTCS Cleared - Minutes the engine has been running since the last time a diagnostic code has been cleared.
MILACT.....	Run Time While MIL Active - Minutes the engine has been running with an active MIL or CEL light.

EMISSIONS

<u>Abbreviation</u>	<u>Parameter Name</u>
---------------------	-----------------------

DPF SL.....	% DPF Soot Load - DPF soot load as a percentage of maximum.
REGEN.....	DPF Regen Status - States if vehicle is in active DPF regeneration cycle.
EGRCMD.....	EGR Commanded - Commanded position of the exhaust gas recirculation valve).
EGRACT.....	EGR Duty Cycle Actual - Actual open percentage of the exhaust gas recirculation valve.
EGRCMD.....	EGR Duty Cycle Commanded - Commanded open percentage of the exhaust gas recirculation valve.

ENGINE PERFORMANCE AIR

<u>Abbreviation</u>	<u>Parameter Name</u>
---------------------	-----------------------

ABSTPS.....	Absolute Throttle Position - Current position of the throttle valve expressed as a percentage.
MAF.....	Mass Air Flow - Flow rate of air mass in intake.
THRCMD.....	Throttle Commanded - Commanded position of the intake throttle valve.
THRPOS.....	Throttle Position - Actual position of the intake throttle valve.
THRREL.....	Throttle Position Relative - Position of accelerator pedal.
VT CMD.....	Turbo Vane Command - Commanded position of the turbocharger vanes.
VT POS.....	Turbo Vane Position - Actual Position of the turbocharger vanes.
WG CMD.....	Wastegate Commanded - Commanded position of the wastegate. expressed as a %.

Engine Performance Fuel (*Banks Exclusive*)

<u>Abbreviation</u>	<u>Parameter Name</u>
---------------------	-----------------------

AFR1/1.....	Air Fuel Ratio Bank1 Sensor1 - Measured Air Fuel Ratio.
AFRCMD.....	Air Fuel Ratio Commanded - Target air fuel ratio request by the ECU.
AFRERR.....	Air Fuel Ratio Error  - Error between the actual and commanded air fuel ratio (negative values are richer mixture).
LOOP.....	Fuel Closed Loop Status - States if vehicle is in open or closed loop fuel control.
FUEL R.....	Fuel Flow Rate - Instantaneous fuel consumption rate volume.
FUEL L.....	Fuel Tank Level - Percentage of fuel remaining in fuel tank.

Section 14:

GLOSSARY, *continued*

TM ADV	Injection Timing Advance - Start of injection angle relative to TDC (after TDC is negative).
LTF1	Long Term Fuel Trim Bank 1 - Historic fueling correction used while in closed loop fueling mode.
STFT1	Short Term Fuel Trim Bank 1 - Instantaneous fueling correction used while in closed loop fueling mode.
TFT 1	Total Fuel Trim Bank 1 -Incorporates long term and short term fuel trim into a single trim value.

Pressure E (*Banks Exclusive*)

Abbreviation	Parameter Name
AAP	Ambient Air Pressure - Pressure of air surrounding vehicle.
BSTCMD	Boost Commanded - Target boost value set by the powertrain control unit.
BOOST	Boost Pressure E - Pressure in intake manifold relative to barometric.
DPFIP1	DPF Inlet Press Bank 1 - Pressure measured at the inlet of the diesel particulate filter.
DPFOP1	DPF Outlet Press Bank 1 - Pressure measured at the outlet of the diesel particulate filter.
FRP	Fuel Rail Pressure - Pressure of fuel in fuel rail.
LIFT P	Lift Pump Fuel Pressure - Pressure of fuel at inlet to the high pressure fuel pump.
MAP	Manifold Absolute Pressure - Pressure in intake manifold relative to vacuum.
P-RAT	Pressure Ratio E - Ratio of Manifold Absolute Pressure compared to Ambient Air Pressure.
TCIP A	Turbo Inlet Pressure A - Air pressure measured at the inlet of the turbocharger.

SPEED AND VELOCITY

Abbreviation	Parameter Name
RPM	Engine RPM - Rotational speed of crankshaft.
TURBO	Turbo A RPM - Rotational speed of turbocharger.
SPEED	Vehicle Speed - Speed of vehicle relative to road.

TEMPERATURE

Abbreviation	Parameter Name
AAT	Ambient Air Temp - Temperature of air surrounding vehicle.
CAC1/1	CAC Temp Bank 1 Sensor 1 - Temperature of the air at the charge air cooler.
CAT1/1	Catalyst Temp Bank 1 Sensor 1 - Temperature of the catalytic convertor.
DPFIT1	DPF Inlet Temp Bank 1 - Temperature measured at the inlet of the diesel particulate filter.
DPFOT1	DPF Outlet Temp Bank 1 - Temperature measured at the outlet of the diesel particulate filter.
EGR1/1	EGR Temp Bank1 Sensor 1 - Temperature of the gas in the EGR system.
ECT	Engine Coolant Temp - ATemperature of engine coolant.
EOT	Engine Oil Temp - Temperature of engine oil.
EGT1/1	Exh Temp Bank 1 Sensor 1 - Temperature of the exhaust gases (sensor 1 is closest to the cylinder head).
IAT	Intake Air Temp - Temperature of air in air filter or entering compressor.

Section 14:

GLOSSARY, *continued*

VEHICLE PERFORMANCE E *(Banks Exclusive)*

<u>Abbreviation</u>	<u>Parameter Name</u>
LOAD	Absolute Engine Load - Normalized air mass per intake stroke as a percent of engine displacement.
APP D	Accelerator Pedal D - Measured position of the accelerator pedal for circuit D.
APPREL	Accelerator Pedal Relative - Position of the accelerator pedal normalized from 0-100%.
HPCALC	Calc Engine Horsepower E - Instantaneous engine horsepower indicated by the power control module (does not account for mods).
TRQCAL	Calc Engine Torque E - Instantaneous engine torque indicated by the power control module (does not account for mods).
LOAD	Calculated Engine Load - Percentage of available engine torque being used.
TRQREF	Engine Reference Torque -Maximum Torque value the engine can produce.
IGN TM.....	Ignition Timing Advance - Ignition timing spark advance in degrees before top dead center for #1 cylinder.
TORQUE	Torque % Actual - Calculated output torque of the engine or indicated torque.
TRQCMD	Torque % Commanded - Requested torque output of the engine by the driver.

VOLTAGE

<u>Abbreviation</u>	<u>Parameter Name</u>
BATT	Battery Voltage - Voltage of the battery measured by the ECU.

Section 15: TROUBLESHOOTING

15.1 Troubleshooting

If the iDash does not power on when installed in the vehicle with the engine running, please check the following items:

- 1.** Push any of the four buttons on the iDash.
- 2.** If the gauge does not power on, check the fuse that powers the vehicle OBDII port. If bad, replace and start again at **Step 1** of this troubleshooting section. If the fuse is good continue to **Step 3**. If the gauge does power on when one of the four buttons is pressed, there is a problem with the CAN communication. If your vehicle is older than 2008, it may not be able to properly communicate with the iDash. If your vehicle does have proper CAN communication, proceed to **Step 3**.
- 3.** Make sure the iDash is properly connected to vehicle as described in **Section 2**.
- 4.** Check the connection at the OBDII diagnostic port (under the driver's side dash area). Check for any damage to the ODB II connector "hood", such as if it has become dislodged from the connector housing.
- 5.** Check the 4-pin connection at the iDash.
- 6.** Unplug the iDash OBDII connector and wait 5 seconds then re-connect the OBDII plug. Some situations can be resolved by resetting the iDash in this manner.

15.2 Troubleshooting*the*

If the gauge powers on but all the values report "--":

- 1.** Verify "Vehicle Selection" in the "Settings" menu is set to "Standard". See Section 11.10
- 2.** If your vehicle is model 2008 or newer you may have a problem with the cable causing a bad connection. Please call tech support for further assistance.
- 3.** If your vehicle is 2007 or older, your vehicle most likely does not support CAN bus OBD-II connection and the iDash will not work on your vehicle.

NOTES

Gale Banks Engineering
546 Duggan Avenue • Azusa, CA 91702
(626) 969-9600 • Fax (626) 334-1743

Product Information & Sales: (888) 635-4565
Customer Support: (888) 839-5600
Installation Support: (888) 839-2700

bankspower.com