

banks

with Installation Instructions

Owner's Manual

Banks Ram-Air® Intake System

2007-2012 Dodge 6.7L Cummins Pickup Trucks

THIS MANUAL IS FOR USE WITH KIT 42175, 42180

Gale Banks Engineering
546 Duggan Avenue • Azusa, CA 91702
(626) 969-9600 • Fax (626) 334-1743

Product Information & Sales: (888) 635-4565
Customer Support: (888) 839-5600
Installation Support: (888) 839-2700

bankspower.com

banks

Products available from Banks Power for the 07-10 Dodge 6.7L

07-10 Dodge 6.7L



Banks Monster Exhaust System

Single (P/N 49764)

Duals (P/N 49765)

Single Dual Tip (P/N 49766)

Duals Quad Tip (P/N 49767)

- Provides increased air flow to the engine by increasing air density for more increased power, lower EGTs and improved fuel economy.

Banks Ram-Air Intake Super-Scoop

(P/N 42190, 03-08 Dodge 5.9L/6.7L

Standard Bumper)

(P/N 42191, 03-07 Dodge 5.9L Painted

Bumper)

- Adds cooler denser air to the Ram-Air Intake housing, further increasing fuel economy, reducing smoke and lowers EGTs.

Banks Techni-Cooler® System

(P/N 25983, 07-08 Dodge 6.7L)

(P/N 25985, 09 Dodge 6.7L)

- Provides increased air flow to the engine by increasing air density for more increased power, lower EGTs and improved fuel economy.

Banks AutoMind® Programmer

(P/N 66108, 07-09 Dodge 6.7L)

- The latest in handheld Flash technology. Improve power, fuel economy and performance.

**For More Information please call (888) 635-4565
or Visit us online @ www.bankspower.com**

General Installation Practices

Dear Customer,

If you have any questions concerning the installation of your Banks Ram-Air System, please call our Technical Service Hotline at (888) 839-2700 between 7:00 am and 4:00 pm (PT). If you have any questions relating to shipping or billing, please contact our Customer Service Department at (888) 839-5600.

Thank you.

1. For ease of installation of your Banks Ram-air intake system, familiarize yourself with the procedure by reading the entire manual before starting work.
2. The exploded view of the Ram-Air assembly (**pages 4-5**) provides only general guidance. Refer to each step and section diagram in this manual for proper instruction.
3. Throughout this manual, the left side of the vehicle refers to the driver's side, and the right-side to the passenger's side.
4. Disconnect the ground cable from the battery before beginning work. If there are two batteries, disconnect both.
5. Route and tie wires and hoses a minimum of 6 inches away from exhaust heat, moving parts and sharp edges. Clearance of 8 inches or more is recommended where possible.
6. During installation, keep the work area clean. If foreign debris is transferred to any Banks system component, clean it thoroughly before installing.
7. When raising the vehicle, support it on properly weight-rated safety stands, ramps or a commercial hoist. Follow the manufacturer's safety precautions. Take

care to balance the vehicle to prevent it from slipping or falling. When using ramps, be sure the front wheels are centered squarely on the topsides; put the transmission in park; set the parking brake; and place blocks behind the rear wheels.

CAUTION! Do not use floor jacks to support the vehicle while working under it. Do not raise the vehicle onto concrete blocks, masonry or any other item not intended specifically for this use.

Notification

The Banks Ram-Air Filter comes pre-oiled and no oiling is necessary for initial installation. Service the filter as specified in the Filter maintenance Section of this manual.

Tools Required:

- 3/8" drive ratchets with metric sockets
- Standard and Phillips head screwdrivers
- Standard and needle-nose pliers
- Clean shop towels or rags
- 5/16 nut driver
- Hack Saw
- Ruler

Table of Contents

Section 1	4
General Assembly	
Section 2	6
Ram-Air Installation	
Section 3	18
Filter Maintenance	

Section 1

GENERAL ASSEMBLY

Figure 1

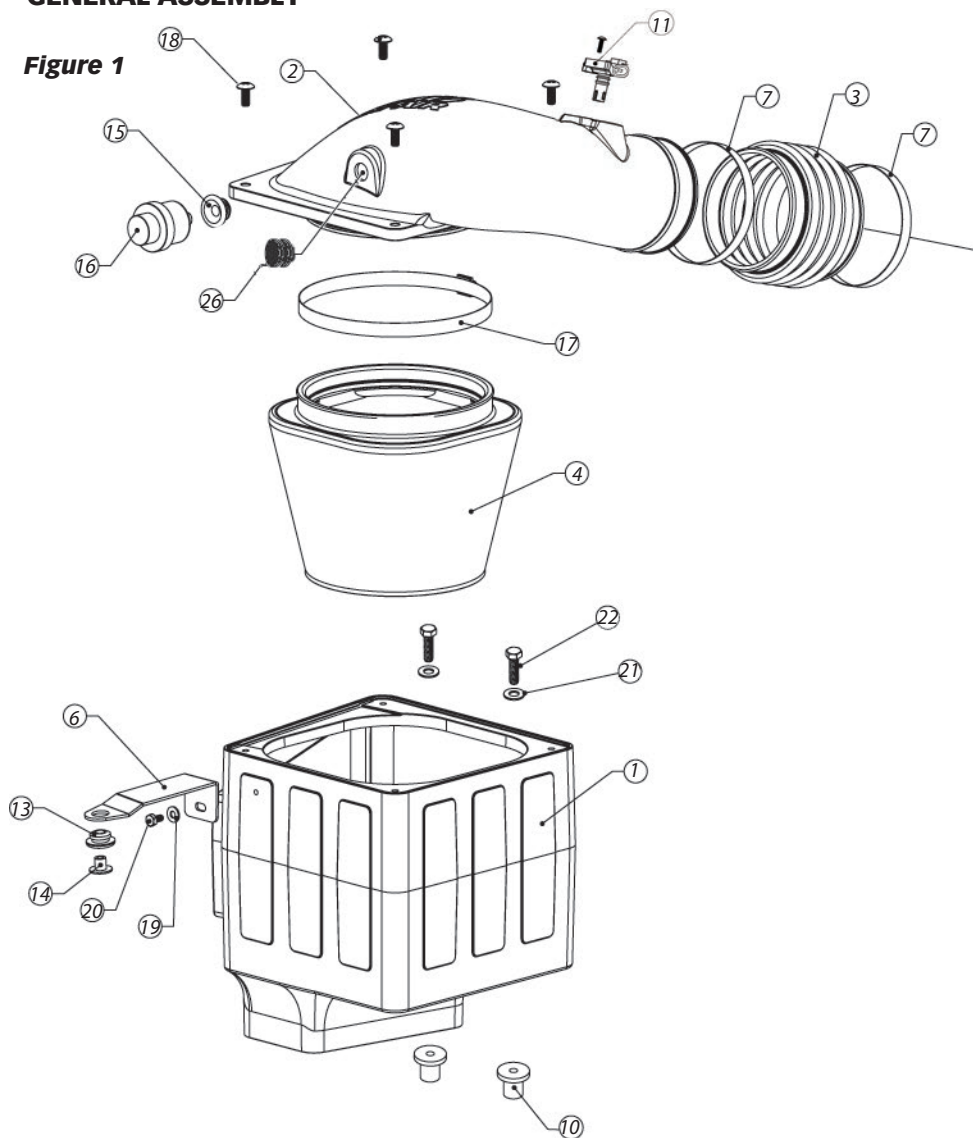

Item	Part #	Description	Qty
1*	42176	HOUSING, RAM-AIR FILTER 07-09 model years	1
1*	42181	HOUSING, RAM-AIR FILTER 2010-2012 model years	1
2	42177	COVER, RAM-AIR HOUSING	1
3	94300	HOSE, BELLOWS, 4.50 I.D.	1
4	42178	AIR FILTER ELEMENT, RAM-AIR SYSTEM	1

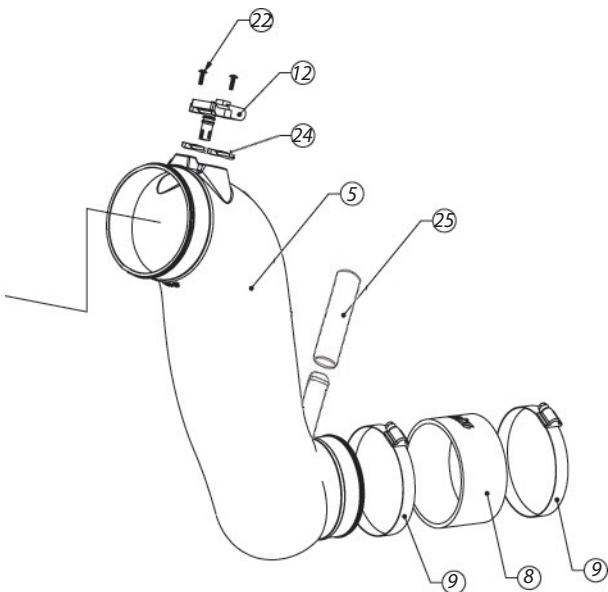

Item	Part #	Description	Qty
5	42179	INTAKE TUBE, RAM-AIR SYSTEM	1
6	42150	BRACKET, SUPPORT, A/F HOUSING	1
7	92872	HOSE CLAMP, #72 W/LINER	2
8	94303	HOSE, COMPRESSOR INLET	1
9	92864	HOSE CLAMP, #64	2
10	91423	WELL-NUT, 3/8"-16, 1.06" LONG	2
11	OEM STOCK	AIR TEMPERATURE SENSO	1
12	OEM STOCK	MASS AIR FLOW SENSOR	1
13	OEM STOCK	GROMMET, STOCK AIR BOX	1
14	OEM STOCK	BUSHING, STOCK AIR BOX	1
15**	OEM STOCK	GROMMET, FILTER MINDER	1
16**	OEM STOCK	FILTER MINDER	1
17	92928	HOSE CLAMP, #128	1
18	91226	SCREW, TRUSS HEAD, PHILLIPS, 5/16-18 X 3/4	3
19	91124	WASHER, SAE FLAT, GOLD ZINC, 1/4	1
20	91115	HEX BOLT, GRADE 5, ZINC, 1/4-20 X 1/2	1
21	91402	WASHER, SAE FLAT, ZINC, 3/8"	2
22	91428	HEX BOLT, GRADE 5, ZINC, 3/8"-16 X 1-1/4"	2
23	91719	SCREW, TRUSS HEAD, PHILLIPS, 6-32 X 1/2", SS	3
24	93069	GASKET, MAF	1
25	94143	HOSE, PCV, 3/4"ID X 8"	1
26	92446	Plug, Filter Minder	1

* 07-09 model years use P/N 42176 & 2010 - 2012 use P/N 42181

** Certain models do not have a factory filter minder installed

Section 2

RAM-AIR INSTALLATION

Use the Bill of Materials Chart and the General Assembly Drawing to reference component nomenclature and location. Use caution when working in the engine compartment. Make sure the engine has been OFF for several hours and cool.

You are about to install the Banks Ram-Air Intake System. Read and follow all steps before working on the vehicle. Some components from the stock air intake system will remain in service. Take care when removing stock air intake components to not damage them.

- 1.** Remove the nut and washer from radiator core support that secures the factory air housing and set aside. See **Figure 2**.
- 2.** Loosen the hose clamp to the stock intake tube attached to the air housing.

- 3.** Press tabs and remove the Intake Air Temperature (IAT) and the Mass Air Flow (MAF) connector sensor.

NOTE: Separate the IAT and MAF wire harness from the negative battery wire harness to provide additional wire length. Secure away from the battery.

- 4.** Remove the air housing by lifting up and out of the engine compartment.

NOTE: There may be slight resistance when removing the air housing feet due to rubber grommets.

- 5.** Remove the factory stock rubber grommets attached to the outside of the battery tray bracket. See Figure 3.

- 6.** Loosen and remove the PCV hose connected to the Intake tube. Loosen the hose clamp, and then remove the factory air intake tube connection attached to the compressor inlet.

*NOTE: Simultaneously lift up and forward to remove the factory intake assembly. See **Figure 4**.*

Figure 2

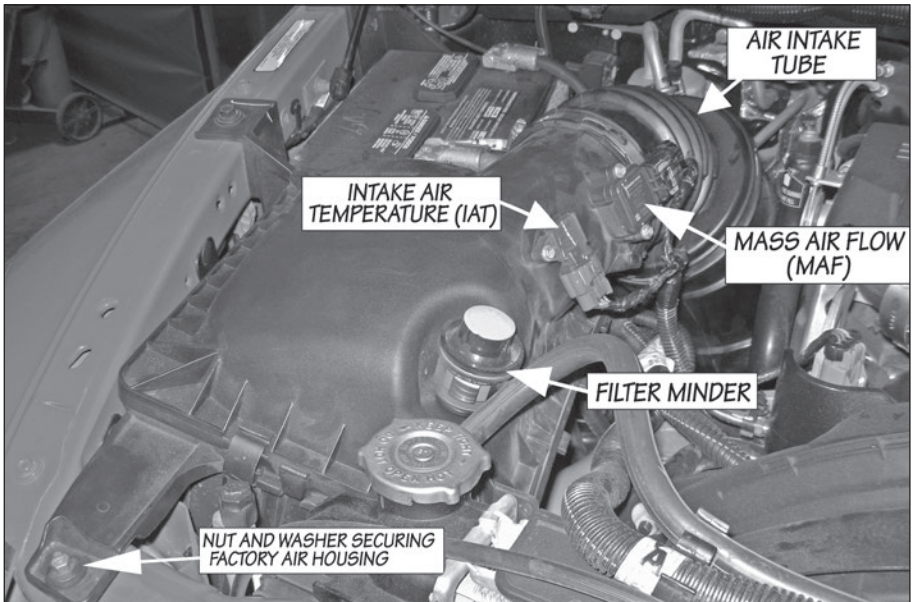

Figure 3

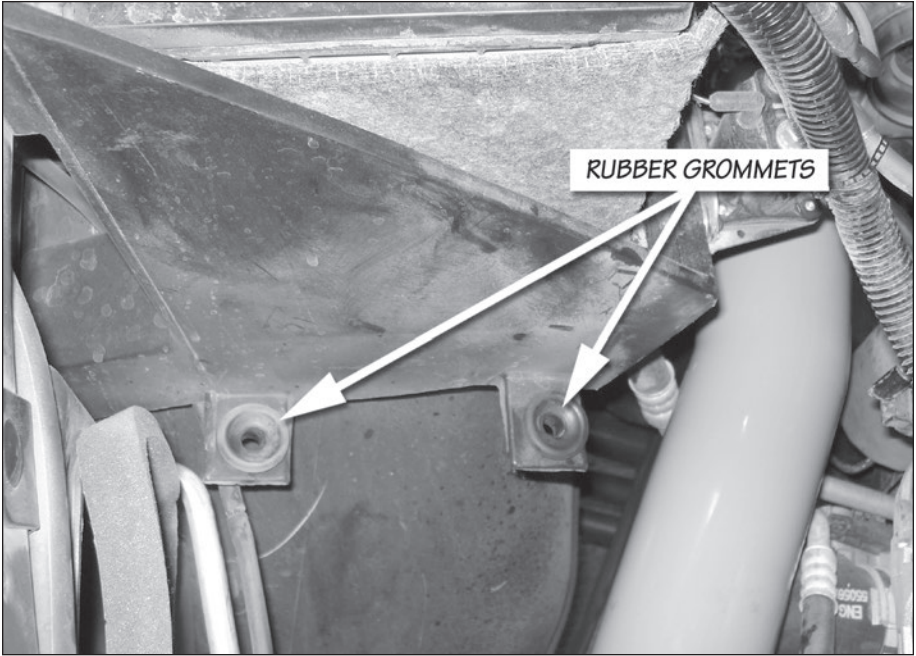

Figure 4

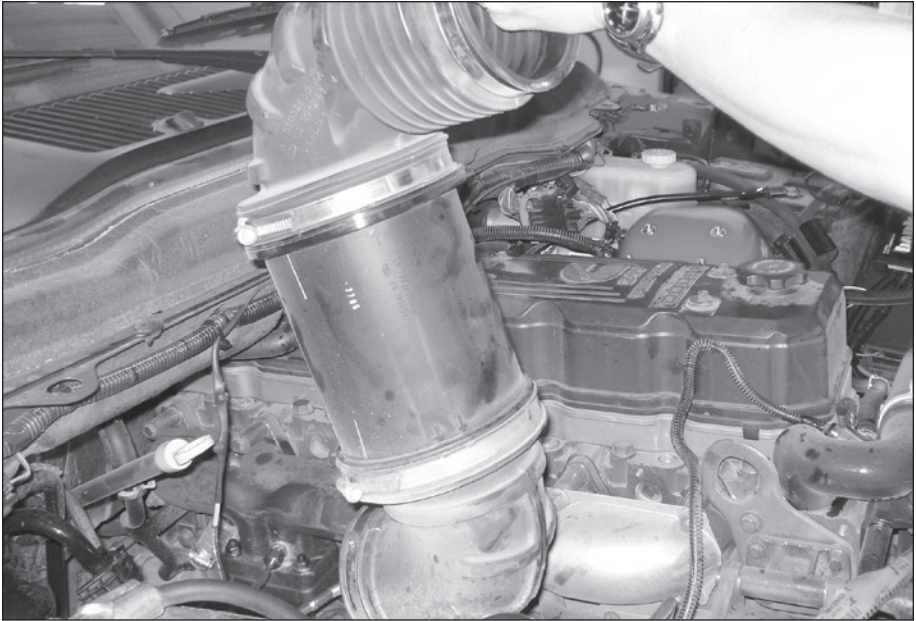

Figure 5



7. Install the supplied rubber Well-Nut as shown in **Figure 5**. Install flange side up, flush with bracket.

If installing the Banks Super Scoop then proceed with steps 8 thru 11. Otherwise, Skip to Step 12.

For Super Scoop Installation Only

8. Locate the Banks air housing. Using a ruler, measure one inch up from the bottom of the housing and repeat several times on all sides of the housing.

9. Make a line that traces the marks you have made around the box (see **Figure 6**).

10. Use your Hack Saw to cut along the line you have made in **Step 9** (see **Figure 7**).

NOTE: Cut housing as straight as possible, it will ease the deburr process.

11. After you have cut off the unneeded portion of the housing, deburr the bottom of the housing to smooth it out and to prevent debris from entering the system.

12. Locate the Banks air housing and Banks air housing bracket in your kit. Hand tighten the air housing bracket to air housing using supplied bolt and washer. See **Figure 8**.

13. Remove the steel insert and rubber grommet from the factory air housing. See **Figure 9**.

14. Insert the rubber grommet flange side down into the air housing bracket.

15. Press in the steel insert and make flush to rubber grommet.

16. Install the Banks air filter housing. Align the radiator core support bolt to the air housing bracket hole. Align the air filter housing holes to threaded Well-Nuts installed in fender bracket. See **Figure 10**.

Figure 6- For Banks Super Scoop Installation Only

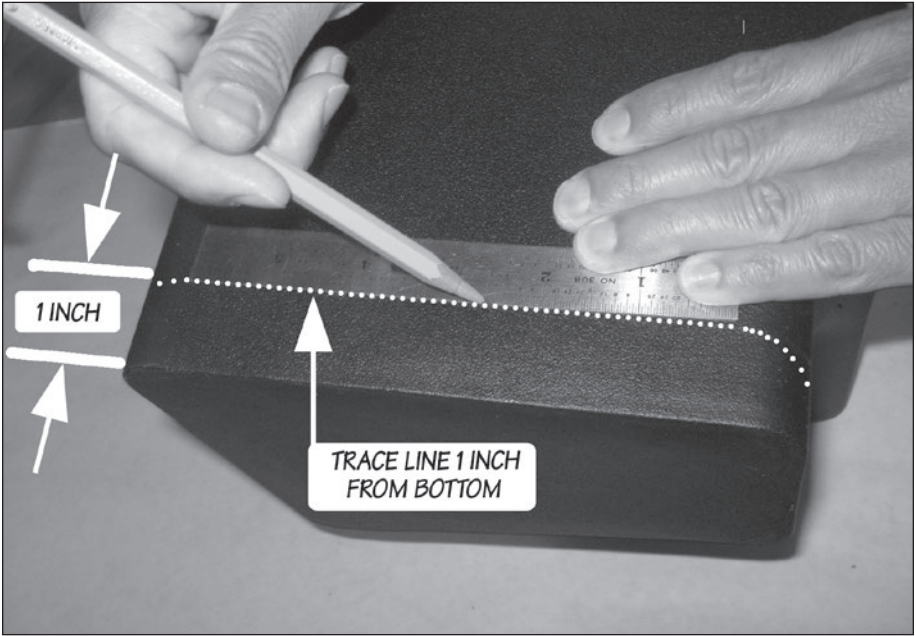

Figure 7- For Banks Super Scoop Installation Only

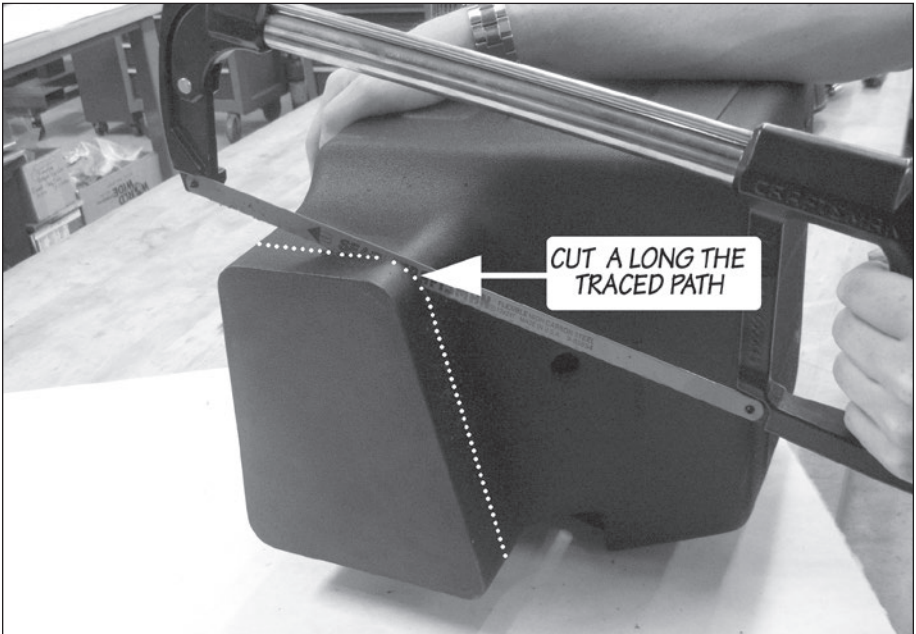

Figure 8



Figure 9



Figure 10



Figure 11

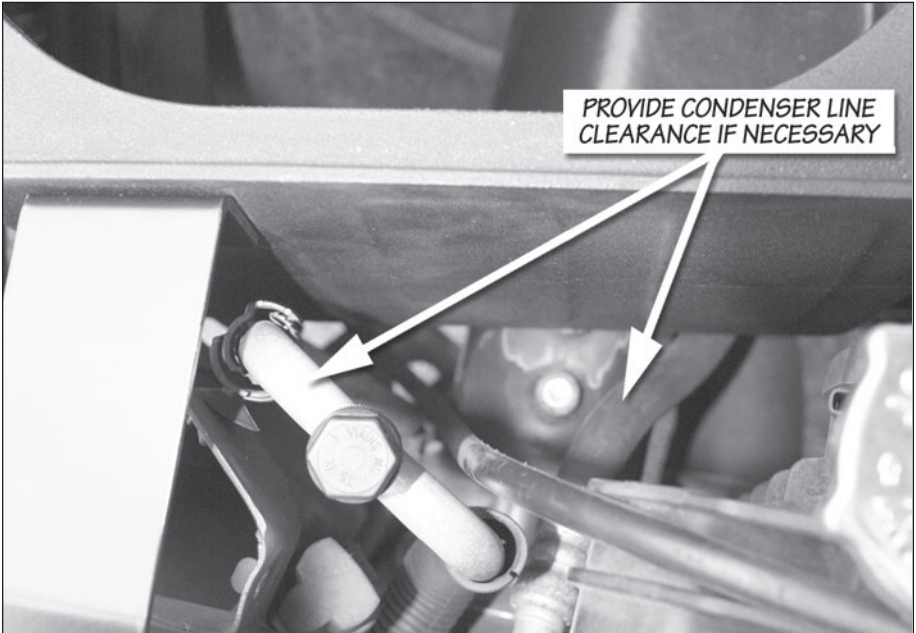
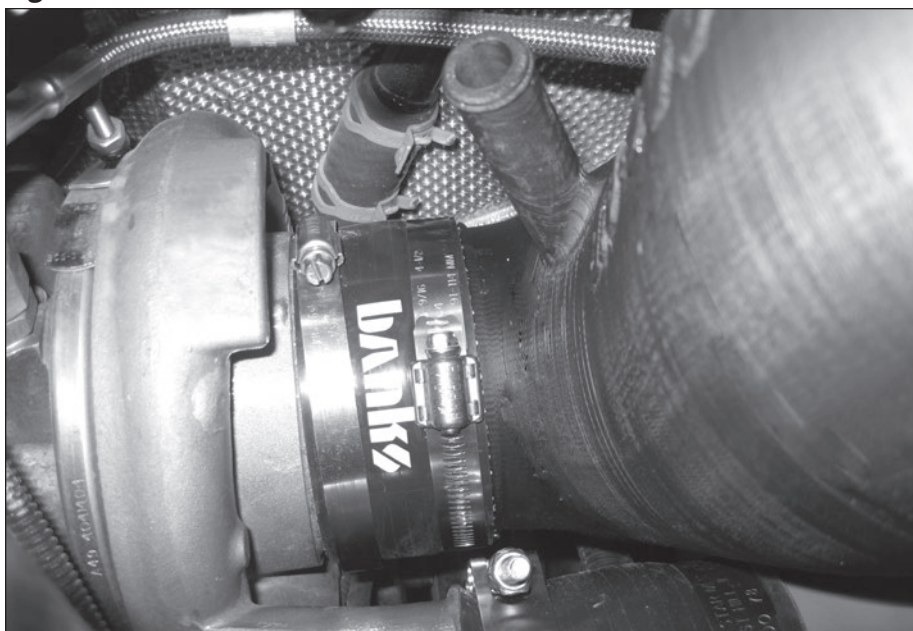

Figure 12



Figure 13



*NOTE: The compressor supply and return lines may need to be slightly bent away from Banks air housing to provide clearance. Be careful not to break the condenser lines when adjusting clearance. See **Figure 11**.*

17. Fasten the Banks air filter housing to the well-nuts by tightening the supplied $\frac{3}{8}$ bolt and washer until snug. Tighten the air housing bracket nut to the radiator core support. Tighten the bracket to the air housing using an open-end wrench. See **Figure 12**.

18. Connect the Banks hose to the Banks inlet tube and tighten hose clamp.

*NOTE: Ensure Banks hose is up to and touching the raised bead on the Banks intake tube. See **Figure 13**.*

19. Install second hose clamp and leave loose.

20. Install Banks intake hose and intake tube to the compressor inlet.

Figure 14

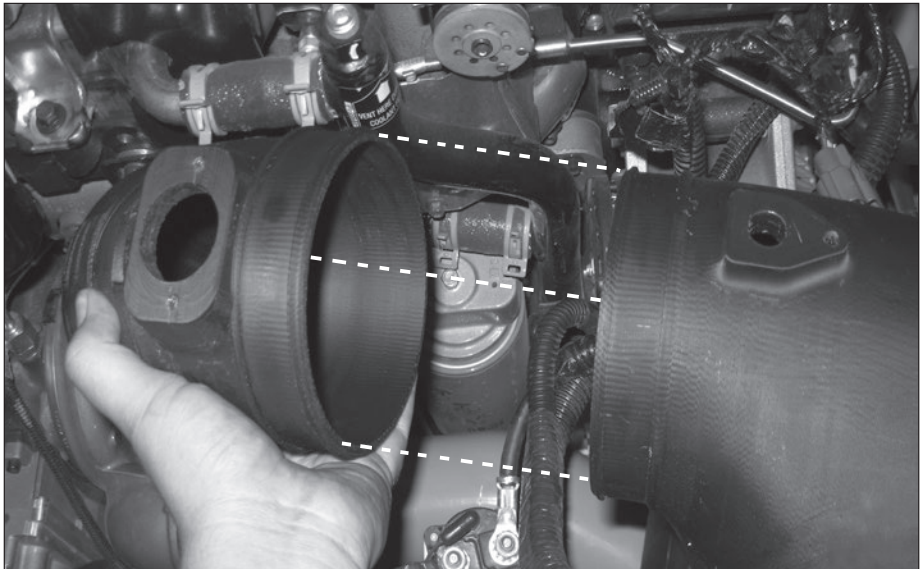

*NOTE: Ensure hose is flush against step on compressor inlet. Hand tighten the hose clamp. See **Figure 13**.*

21. Place Banks air filter cover onto the Banks air filter housing.

22. Align intake tube with cover, and then tighten the hose clamp on turbo compressor inlet. See **Figure 14**.

NOTE: To provide additional clearance straighten the negative battery harness under the intake tube so that they lay flat and loose under the intake.

23. Locate the supplied PCV hose and insert one end into the intake tube. Insert the other end into the PCV tube. Make sure the hose is properly inserted.

For vehicles equipped with a factory Filter Minder

24. Remove factory filter minder from factory air housing. Remove rubber grommet from factory air housing.

Figure 15

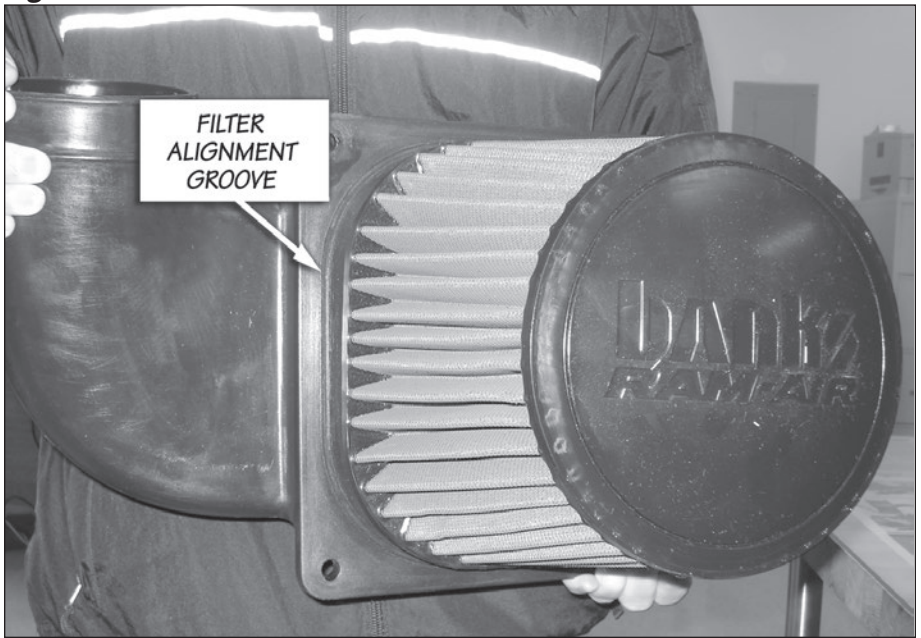

Figure 16



Figure 17

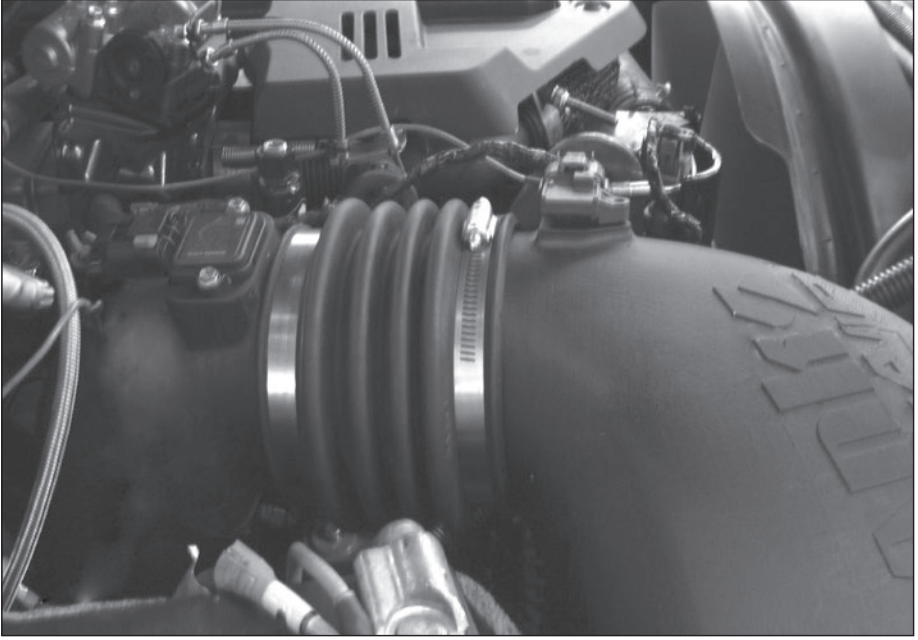
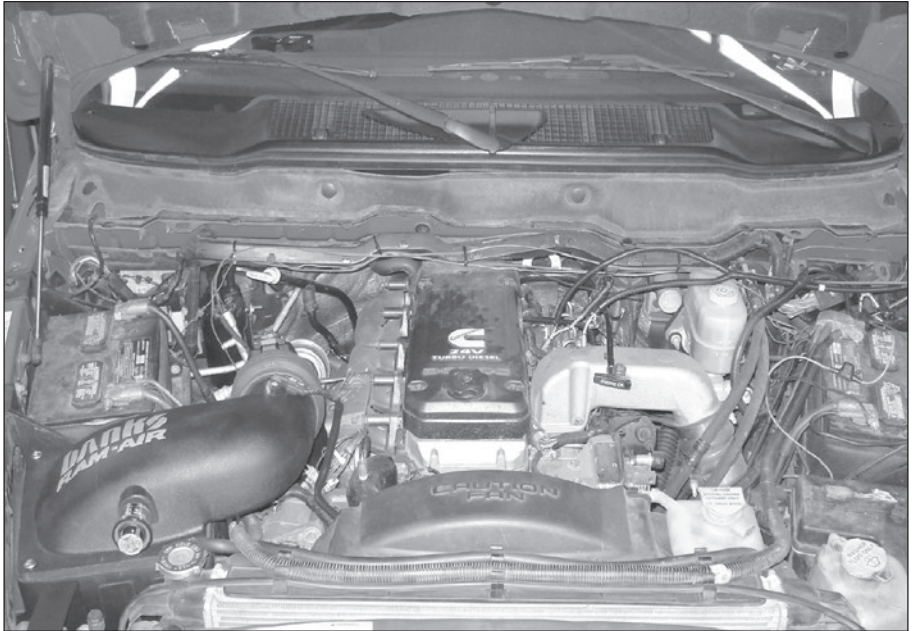

Figure 18



25. Install factory filter minder rubber grommet into the Banks cover. Insert the factory filter minder into rubber grommet.

All Vehicles

26. Remove cover from housing. Install Banks bellows with hose clamps to Banks Intake tube.

27. Loosely install the hose clamp to the Banks air filter.

28. Install Banks air filter onto the Banks cover. Note the audible snap. Tighten the hose clamp on the air filter. Make sure the air filter is lined up with the alignment groove. See **Figure 15**.

29. Insert the Banks cover into the Banks bellows. Place cover on to housing and tighten the hose clamp. See **Figure 16**.

30. Using supplied screws fasten the banks cover to the air filter housing.

31. Remove the stock IAT and MAF sensors from the factory air housing.

32. Install IAT sensor into Banks cover using supplied $\frac{6}{32}$ screws. Locate the supplied MAF gasket and install over MAF sensor. Install MAF sensor and gasket into the Banks intake tube using the supplied $\frac{6}{32}$ screws. See **Figure 17**.

NOTE: Ensure that o-rings are in good condition.

33. Connect the IAT and MAF connector to the IAT and MAF sensor.

*NOTE: For added length in the IAT and MAF sensor wires, separate the two wire bundles by CAREFULLY removing the tape holding them together. See **Figure 19**. Route harness away from the exhaust manifold heat shield.*

34. Re-connect battery grounds. You have successfully completed the installation of the Banks Ram-Air Intake system. See **Figure 18**. Make sure to go over all hose clamps for tightness and connectors for a sure fit. Make sure that the intake tube is not touching any engine components.

Figure 19

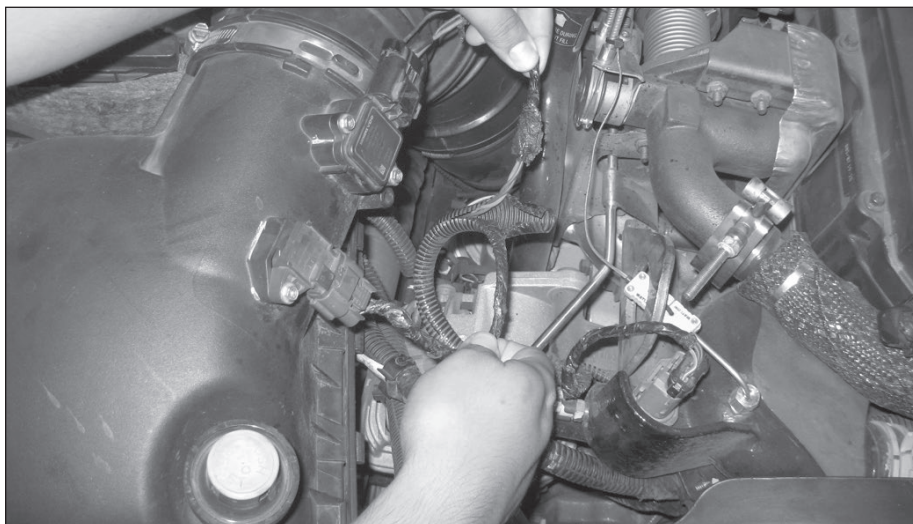

For Vehicles without a factory Filter Minder

35. Insert Banks Filter Minder Plug into hole on the Banks Air Intake Housing if your vehicle does not come equipped with a Filter Minder.

-END, SECTION 2-

Section 3

AIR FILTER CLEANING INSTRUCTIONS

OILED AIR FILTER ONLY

NOTICE: The Banks Ram-Air Oiled Air Filter comes pre-oiled and no oiling is necessary for initial installation. Use Banks Ram-Air Filter Cleaning System (part#90094), available from Gale Banks Engineering to service the Air Filter. Follow the instructions included with the cleaning system to clean and re-oil your Bank Ram-Air Oiled Air Filter.

1. PRE-CLEANING

Tap the element to dislodge any large embedded dirt, then gently brush with a soft bristle brush. *NOTE: If complete cleaning is not practical at this time, reoil the element and reinstall in your vehicle.*

2. SPRAY-ON CLEANING

Spray air-filter cleaner liberally onto the entire element and let soak for 10 minutes.

3. PAN CLEANING

Large air-filter elements can be rolled or soaked in a shallow pan of air-filter cleaner. Remove immediately and let soak for approximately 10 minutes.

NOTICE: NEVER use gasoline, steam, caustic solutions, strong detergents, high-pressure nozzles, or cleaning solvents to clean the filter element. All of these can cause harm to the filter media as well as SHRINK and HARDEN the rubber end caps.

4. RINSING

Rinse off the element with low-pressure water. Tap water is okay. Always flush from the clean side to dirty side. This removes the dirt and does not drive it into the filter.

5. DRYING

Always dry naturally. After rinsing, shake off all excess water and let the element dry naturally.

6. AEROSOL OILING

After cleaning air filter always reoil before using. Spray air filter oil down into each pleat with one pass per pleat. Wait 10 minutes and re-oil any white spots still showing.

7. OILING HINTS

Never use a Banks Ram-Air filter without oil (the filter will not stop the dirt without the oil). Use only air filter oil. Air-filter oil is a compound of mineral and animal oil blended with special polymers to form a very efficient tack barrier. Red dye is added to show just where you have applied the oil. Eventually the red color will fade but the oil will remain and filter the air. NEVER USE Automatic Transmission Fluid. NEVER USE Motor Oil. NEVER USE Diesel Fuel. NEVER USE WD40, LPS, or other light-weight oils.

8. REINSTALL

Reinstall your Banks Ram-Air filter element with proper care. Make sure the element seats properly in the filter case. Install the cover making sure it's in the right position. Tighten all the nuts, bolts, screws or clips to factory specifications.

9. DO NOT DISCARD

Affix the "Do Not Discard" sticker to the filter case (included with every Banks replacement element). Make sure you put the sticker in a highly visible place to alert your mechanic not to discard.

10. PERFORMANCE HINTS

Service every 50-100,000 miles on street-driven applications. Service more often in offroad or heavy-dust conditions. If an air-filter restriction

gauge is installed, then change the element when the air-filter restriction reaches 18"–H.O.

⚠ CAUTION: **Extremely fine dust from agriculture or offroad use will pull the oil from the element. Frequent reoiling of the element's clean side might be required. Completely service when practicable. For extra protection use an air-filter sealing grease on rubber ends of the element. Service only with air-filter cleaner and air-filter oil.**

DRY FILTER CLEANING

Clean every 50-100,000 miles on street-driven applications. Clean more often in offroad or heavy-dust conditions. If an air-filter restriction gauge is installed, then change the element when the air-filter restriction reaches 18"–H.O.

1. PRE-CLEANING

Carefully tap the air filter element to dislodge any large embedded dirt or debris.

2. CLEANING

Spray an appropriate DRY AIR-FILTER CLEANER SOLUTION liberally onto both sides of the entire filter element with the majority applied to the dirty side. Soak for 10 minutes. Do not allow the DRY AIR-FILTER CLEANER SOLUTION to dry on the air filter.

NOTICE: **NEVER use gasoline, steam, caustic solutions, strong detergents, high-pressure nozzles, or cleaning solvents to clean the filter element.** All of these can cause harm to the filter media as well as SHRINK and HARDEN the rubber end caps.

3. RINSING

Rinse the filter element with cool or warm (not hot) water from the clean side out in order to flush the dirt out of the filter. It may be necessary to use your fingers on the hose to apply light water pressure. Repeat steps 2 and 3, until the water flowing through the media is completely clear of any dirt and debris.

5. DRYING

After rinsing, gently shake off excessive water and allow to dry naturally. Re-install the filter onto the intake system, airbox or custom assembly once it is dry or just slightly damp. Follow all original installation instructions.

6. REINSTALL

Reinstall your Banks Ram-Air filter element with proper care. Make sure the element seats properly in the filter case. Install the cover making sure it's in the right position. Tighten all the nuts, bolts, screws or clips to factory specifications.

7. DO NOT DISCARD

Affix the "Do Not Discard" sticker to the filter case (included with every Banks replacement element). Make sure you put the sticker in a highly visible place to alert your mechanic not to discard.

8. PERFORMANCE HINTS

Service every 50-100,000 miles on street-driven applications. Service more often in offroad or heavy-dust conditions. If an air-filter restriction gauge is installed, then change the element when the air-filter restriction reaches 18"–H.O.

-END, SECTION 3-

Gale Banks Engineering
546 Duggan Avenue • Azusa, CA 91702
(626) 969-9600 • Fax (626) 334-1743

Product Information & Sales: (888) 635-4565
Customer Support: (888) 839-5600
Installation Support: (888) 839-2700

bankspower.com