



**DOWNLOAD THE LATEST  
INSTALL MANUALS AT  
[www.bddiesel.com](http://www.bddiesel.com)**



**BD FORD 6.0L PERFORMANCE**  
**EXHAUST MANIFOLD**  
Installation Instructions

Application List

Ford Powerstroke 2003-07	6.0L	1041480
--------------------------	------	---------

**PLEASE READ ALL INSTRUCTIONS BEFORE INSTALLATION**

**Replaces OEM # 3C3Z9431AB, 1840994C1**

BD Engine Brake Inc.



Plant Address: 33541 MacLure Rd. Abbotsford, BC, Canada V2S 7W2

U.S. Shipping Address: 88-446 Harrison St, Sumas, WA 98295 U.S. Mailing Address: P.O. Box 231, Sumas, WA 98295

Phone: 604-853-6096 | Fax: 604-853-8749 | Internet: [www.bd-power.com](http://www.bd-power.com)

# KIT CONTENTS:

Please check to make sure that you have all the parts listed in this kit **before** you start the disassembly of your truck.

Ford 2003-08 Performance Manifold (BD# 1041480)		
1401480-1	1401480-2	1200208
		
<i>Passenger side manifold</i>	<i>Driver side manifold</i>	<i>1/8" NPT Brass Plug</i>
<b>Qty: 1</b>	<b>Qty: 1</b>	<b>Qty: 1</b>
1900014	1900013	
		
<b>Flange nut</b>	<b>Flange bolt 60 mm Long</b>	
<b>Qty: 4</b>	<b>Qty: 4</b>	

## ***Options***

<b>Description</b>	<b>Part #</b>
Ford 6.0L Manifold Gasket Set	Ford Part # 6C3Z9448-A
Ford 6.0L Manifold Bolts	Ford Part # 3C3Z9S425AA
Ford 6.0L Manifold Spacers	Ford Part # 3C3Z9A461AA
Ford 6.0L Exhaust pressure tube adapter	Ford Part # 3C3Z9D477BA

BD Engine Brake Inc.

Plant Address: 33541 MacLure Rd. Abbotsford, BC, Canada V2S 7W2

U.S. Shipping Address: 88-446 Harrison St, Sumas, WA 98295 U.S. Mailing Address: P.O. Box 231, Sumas, WA 98295

Phone: 604-853-6096 | Fax: 604-853-8749 | Internet: www.bd-power.com

## Removal

### (Driver side)

1. Position vehicle on a hoist and chock wheels to prevent vehicle from rolling. Disconnect the Negative terminals on both batteries.

2. Remove the 2 driver side exhaust manifold to turbocharger adapter pipe nuts.

NOTE: These bolts may be easier to access if the inner fender liner is removed.

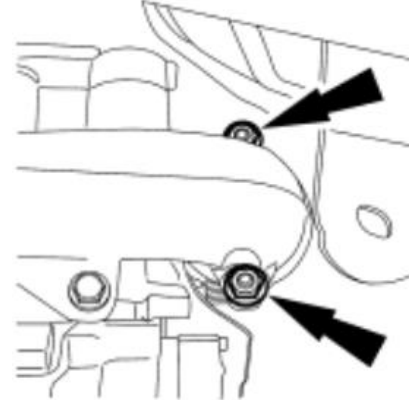

3. Disconnect the exhaust pressure tube from the driver side exhaust manifold.
4. Remove the 8 bolts, 8 spacers and the driver side exhaust manifold.

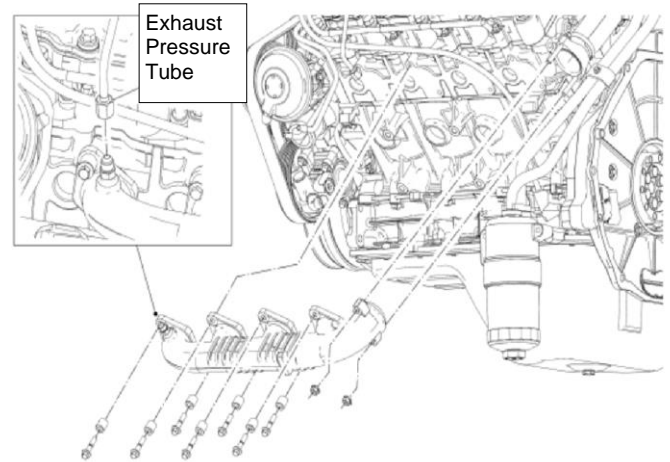

BD Engine Brake Inc.

Plant Address: 33541 MacLure Rd. Abbotsford, BC, Canada V2S 7W2

U.S. Shipping Address: 88-446 Harrison St, Sumas, WA 98295 U.S. Mailing Address: P.O. Box 231, Sumas, WA 98295

Phone: 604-853-6096 | Fax: 604-853-8749 | Internet: [www.bd-power.com](http://www.bd-power.com)

**(Passenger side)**

5. Remove the transmission fluid indicator. Remove the retaining nut and position the transmission fluid tube off the stud. Separate the transmission fluid tube and position aside.

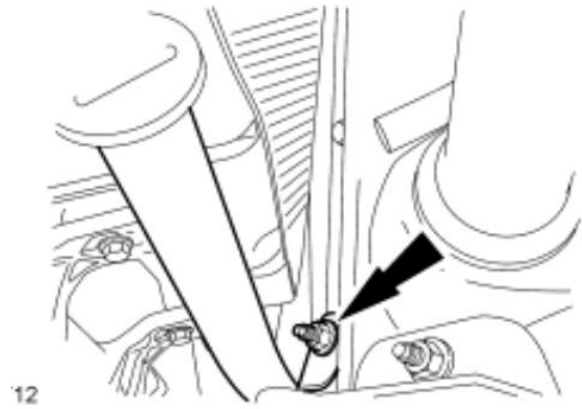

6. Remove the 2 passenger side exhaust manifold to turbocharger adapter pipe nuts.

NOTE: These bolts may be easier to access if the inner fender liner is removed.

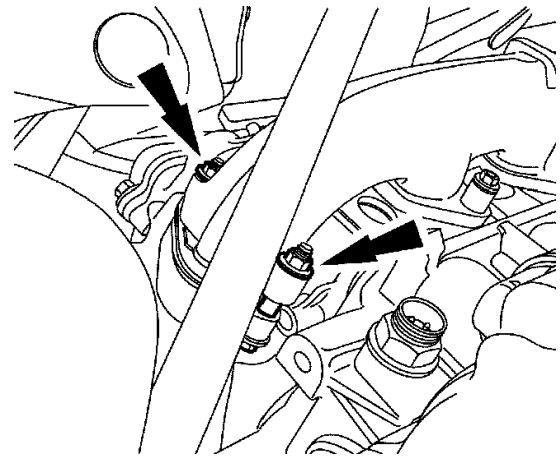

7. Remove the 8 bolts, 8 spacers and the passenger side exhaust manifold.

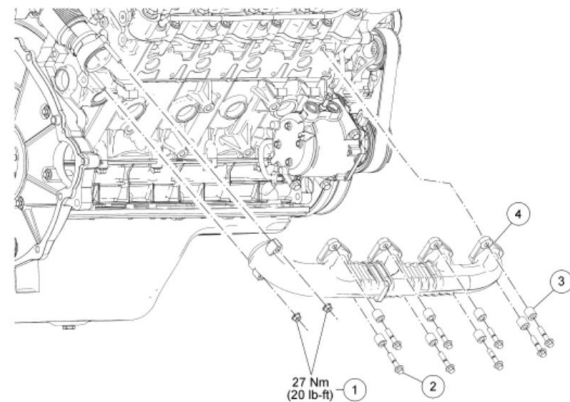

BD Engine Brake Inc.

Plant Address: 33541 MacLure Rd. Abbotsford, BC, Canada V2S 7W2

U.S. Shipping Address: 88-446 Harrison St, Sumas, WA 98295 U.S. Mailing Address: P.O. Box 231, Sumas, WA 98295

Phone: 604-853-6096 | Fax: 604-853-8749 | Internet: www.bd-power.com

# Installation



## Install Notes:

- ◆ Installing the bolts with the small diameter hole will assist in the alignment of the remaining bolts.
- ◆ When installing the exhaust manifolds, only use prevailing torque hex flange bolts with an interference fit.
- ◆ Apply anti-seize lubricant to the bolt threads prior to installing the bolts.

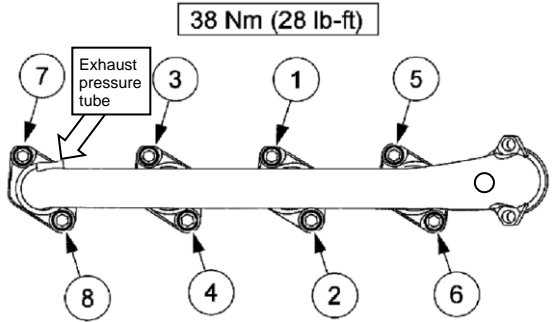
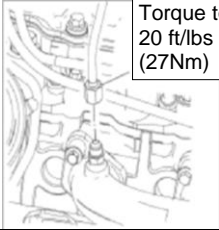
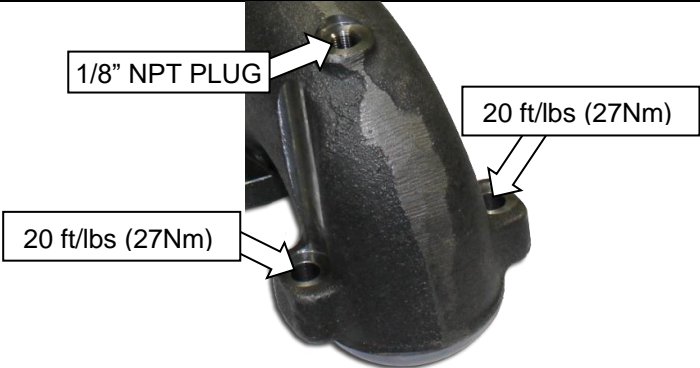
### (Driver Side)

<p>1. Install the driver side exhaust manifold and tighten the OEM bolts and spacers in the sequence shown to 28 ft/lbs (38 Nm)</p>	
<p>2. Connect the exhaust pressure tube to the exhaust manifold and tighten to 22ft/lbs (30Nm)</p>	
<p>3. Install supplied driver side exhaust manifold to turbocharger adapter bolts (1900013) &amp; nuts (1900014) and tighten to 20 ft/lbs (27Nm)</p> <p><b>NOTE:</b> If no pyro is used; insert 1/8" NPT supplied plug.</p>	

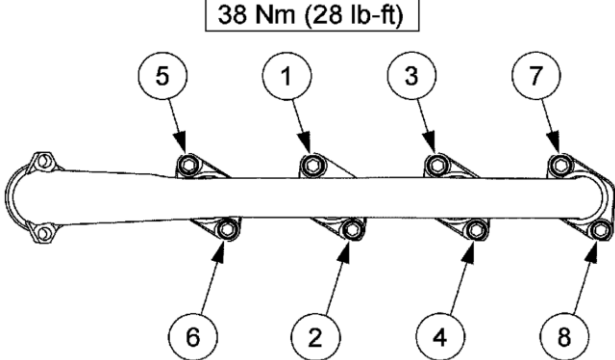
**(Passenger Side)**

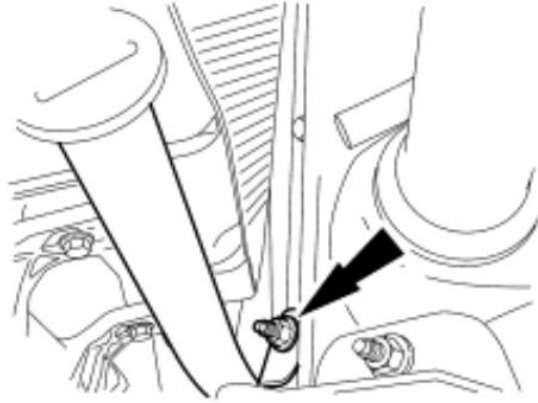
<p>4. Install the passenger side exhaust manifold and tighten the 8 OEM bolts and spacers in the sequence shown to 28 ft/lbs (38 Nm)</p>	
<p>5. Install supplied passenger side exhaust manifold to turbocharger adapter bolts (1900013) &amp; nuts (1900014) and tighten to 20 ft/lbs (27Nm)</p>	
<p>6. Reconnect the transmission fluid tube and position the tube on the stud; install the retaining nut. Re-insert the transmission fluid indicator.</p>	
<p>7. Reconnect the negative terminals on both batteries and check for exhaust manifold leaks. Installation is complete.</p>	