

FIRMAN[®]

OPERATOR'S MANUAL DUAL FUEL PORTABLE GENERATOR

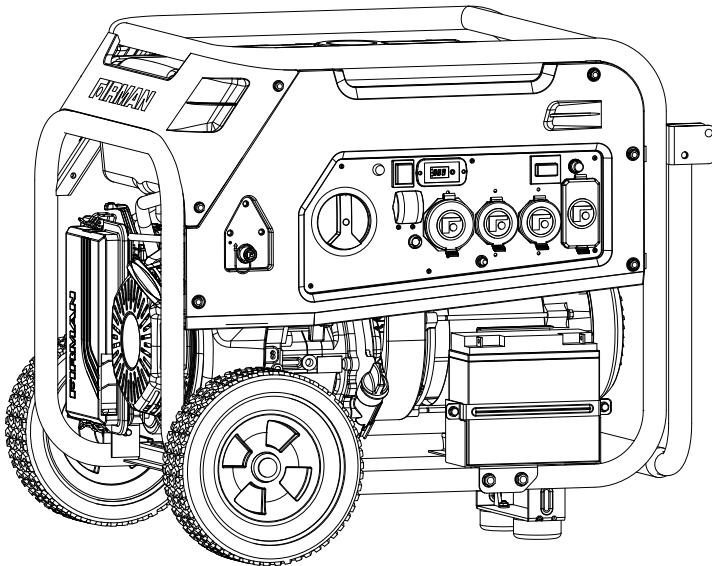

MODEL NUMBER
H08052
Rev Level:00

Record product information to reference when ordering parts or obtaining warranty coverage.

SERIAL NUMBER: _____

PURCHASE DATE: _____

STOP DO NOT RETURN TO STORE!

CALL US FIRST
1-844-347-6261

FOR QUESTIONS OR SERVICE INFORMATION



INTRODUCTION

Table of Contents

Introduction	1
Features and Controls	5
Operation	10
Maintenance - Storage	25
Troubleshooting- Specifications	32
Parts Diagrams - Parts Lists - Wiring Diagram	34
Service - Warranty	40

REGISTER YOUR PRODUCT

Register your product using the QR code provided or at www.firmanpowerequipment.com.





INTRODUCTION

Thank you for purchasing a FIRMAN generator. You have selected a high-quality, precision engineered generator set designed and tested to give you years of satisfactory service. This generator is Dual Fuel and capable of running on gasoline and liquid petroleum gas (LPG). This generator is not intended to be run unattended or to supply power to life safety support.

This manual contains safety information to make you aware of the hazards and risks associated with generator products and how to avoid them. This generator is designed and intended only for supplying electrical power for operating compatible electrical lighting, appliances, tools and motor loads, and is not intended for any other purpose. It is important that you read and understand these instructions thoroughly before attempting to start or operate this portable generator. Save these original instructions for future reference.

All information in this publication is based on the latest production information available at the time of approval for printing. The manufacturer reserves the right to change, alter or otherwise improve the generator and this documentation at any time without prior notice.

SIGNAL WORDS

 DANGER	 WARNING	 CAUTION	NOTICE
Indicates a hazard which, if not avoided, will result in death or serious injury.	Indicates a hazard which, if not avoided, could result in death or serious injury.	Indicates a hazard which, if not avoided, could result in minor or moderate injury.	Indicates information considered important, but not hazard-related.



Safety Alert Symbol- Indicates a potential personal injury hazard.



Operator's Manual- Failure to follow warnings, instructions and operator's manual could result in death or serious injury.



Toxic Fumes- Engine exhaust contains carbon monoxide, a poisonous gas that will kill you in minutes. You cannot smell it or see it.



Generator could cause electrical shock resulting in death or serious injury.



Fire- Fuel and its vapors are extremely flammable which could cause burns or fire resulting in death or serious injury. Engine exhaust could cause fire resulting in death or serious injury.



Hot Surface- Muffler could cause burns resulting in serious injury.

INTRODUCTION



WARNING! This product can expose you to chemicals including gasoline engine exhaust, which is known to the State of California to cause cancer, and carbon monoxide, which is known to the State of California to cause birth defects or other reproductive harm. For more information go to www.P65Warnings.ca.gov.

This outdoor generator can be used to power outdoor items using extension cords or to restore home power using a transfer switch. A transfer switch is a separate device installed by a licensed electrician that allows the portable generator to be cord connected, using either of the 120/240V receptacles, directly into your home's electrical system. Install a listed transfer switch as soon as possible if this generator will be used to restore power to your home.

NOTICE If you have questions about intended use, contact FIRMAN customer service. This portable generator is designed to be used only with FIRMAN authorized parts.

System Ground

The generator has a system ground that connects the generator frame components to the ground terminals on the AC output receptacles. The system ground is connected to the AC neutral wire. The neutral is bonded to the generator frame.

Compliance Requirements

There may be Federal or State regulations, local codes, or ordinances that apply to the intended use of the generator. Consult a qualified electrician, electrical inspector, or the local agency having jurisdiction. This generator is not intended to be used at a construction site or similar activity as defined by NFPA 70-2020 (NEC) section 590.6.

To Restore Home Power Using a Listed Transfer Switch

Connections to your home's electrical system must use a listed* transfer switch installed by a licensed electrician. The connection must isolate the generator power from the utility power and comply with all applicable laws and electrical codes.

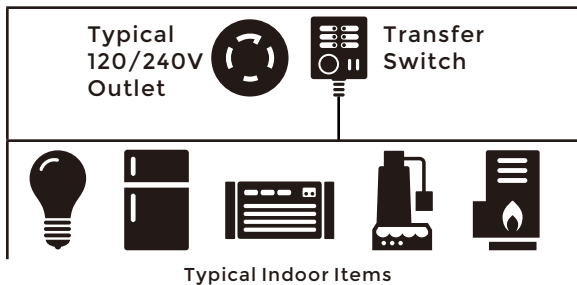

To Restore Power Using Extension Cords

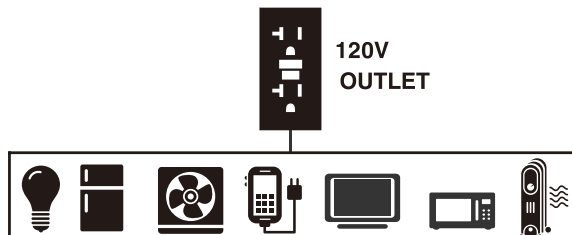

1. Only use grounded cords marked for outdoor use rated for your loads.

Total Amperage	Minimum Gauge, Outdoor Rated
	Up to 50 FT (15m)
Up to 13A	16
Up to 15A	14
Up to 20A	12
Up to 30A	10
Up to 50A	6



To provide power using extension cords

2. Follow cord safety instructions.

3. Install carbon monoxide alarm(s).

4. When operating portable generator with extension cords, make sure portable generator is located downwind in an open, outdoor area, at least 20 ft. (6 m.) from occupied spaces with exhaust pointed away.

5. Extension cords running directly into your home, powering indoor items IS NOT RECOMMENDED.



DANGER! Engine exhaust contains carbon monoxide, a poisonous gas that will kill you in minutes. You cannot smell it, see it, or taste it. Even if you do not smell exhaust fumes, you could still be exposed to carbon monoxide gas.

- Extension cords running directly into the home increase your risk of carbon monoxide poisoning through any openings.
 - If an extension cord running directly into your home is used to power indoor items, the operator recognizes that this increases the risk of CO poisoning to people inside the home and assumes that risk.
6. Install a listed *transfer switch as soon as possible if this or any generator will be used to restore power to your home.

*Certified by a Nationally Recognized Testing Laboratory that the product complies to appropriate product safety test standards.

FEATURES AND CONTROLS

Generator

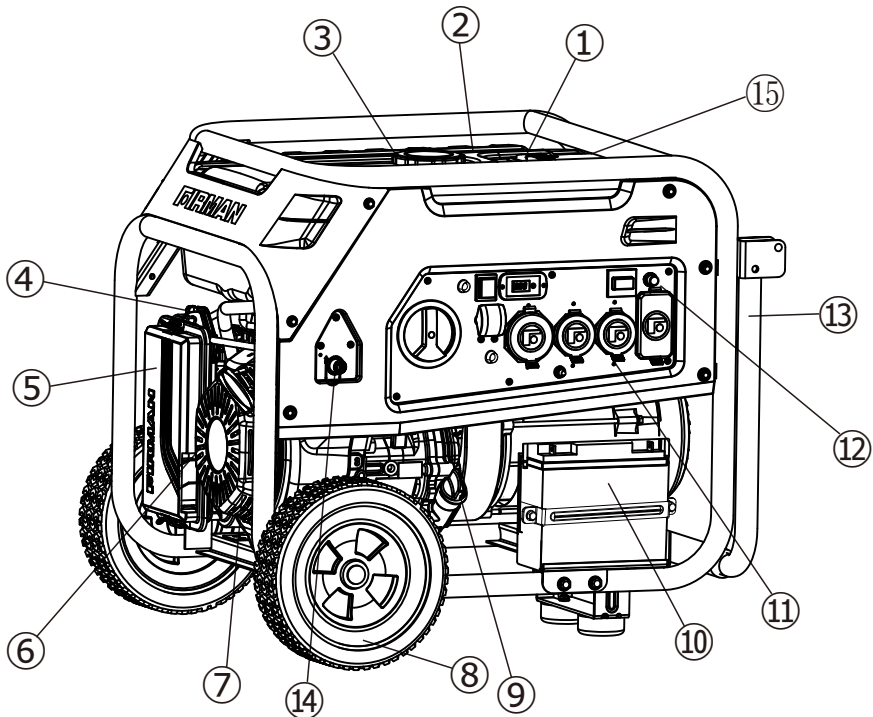

- | | |
|--|---------------------------------------|
| 1- Fuel Gauge | 10- Battery |
| 2- 8.0 Gallon Capacity Fuel Tank | 11- Outlet Cover |
| 3- Fuel Cap | 12- Control Panel |
| 4- Choke Lever(behind air filter box) | 13- Handle |
| 5- Air Filter | 14- LPG Hose Connector(Inlet) |
| 6- 439cc FIRMAN OHV Engine | 15. Data Decal / Serial Number |
| 7- Recoil Starter | |
| 8- 10.0" Flat Free Wheel | |
| 9- Oil Filler Cap | |

*We are always working to improve our products. Therefore, the enclosed product may differ slightly from the image on this page.

FEATURES AND CONTROLS

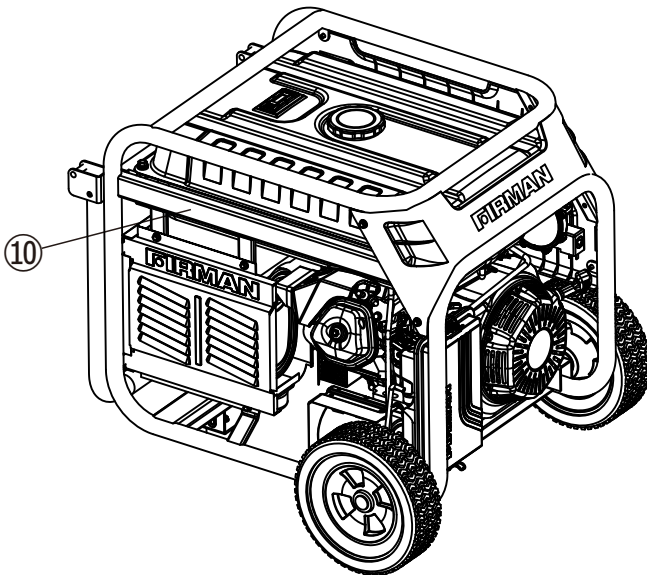
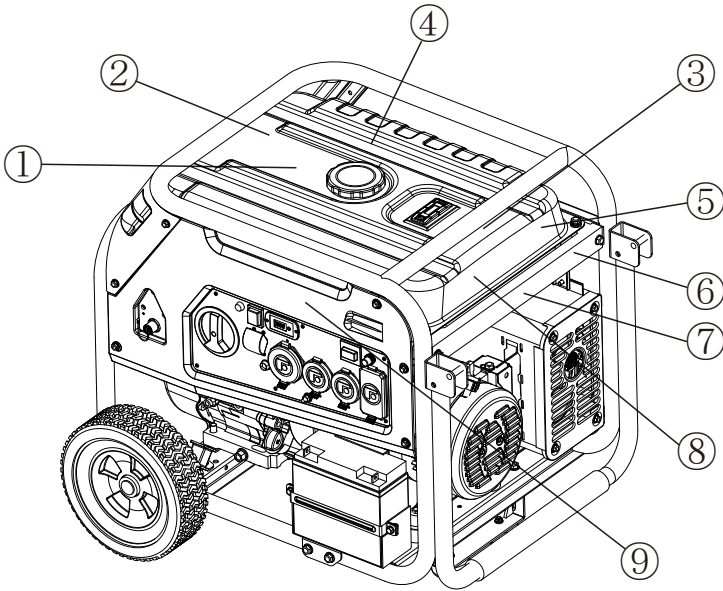



FEATURES AND CONTROLS

①

⚠ DANGER	⚠ PELIGRO	⚠ DANGER
 Failure to follow warnings, instructions and operator's manual will result in death or serious injury.	 El incumplimiento de las advertencias, las instrucciones y el manual del operador provocará la muerte o lesiones graves.	 Le non-respect des avertissements, des instructions et du manuel de l'opérateur entraînera la mort ou des blessures graves.
 Tampering with the CO ALERT system will cause Carbon Monoxide poisoning. Install Carbon Monoxide alarms inside home.	 La alteración del sistema de alerta de CO causará envenenamiento por monóxido de carbono. Instale detectores de Monóxido de Carbono dentro de su casa.	 Toute altération du système D'ALERTE du monoxyde de carbone causera un empoisonnement au monoxyde de carbone. Installez des détecteurs de monoxyde de carbone à l'intérieur de la maison.
 Generator could cause electrical shock. •Do not run indoors to avoid wet conditions. •Do not run in rain or wet weather. •Transfer switch must be used when connecting to a home's electrical system.	 El generador podría producir una descarga eléctrica. •No utilice en interiores para evitar condiciones de humedad. •No utilice en la lluvia o en condiciones de humedad. •Es necesario usar un interruptor de transferencia cuando se conecta al sistema eléctrico de una casa.	 La génératrice pourrait provoquer un choc électrique. •Ne faites pas fonctionner à l'intérieur pour éviter les conditions humides. •Ne faites pas fonctionner sous la pluie ou par temps pluvieux. •Un commutateur de transfert doit être utilisé lors du raccordement au système électrique d'une maison.
 Hot exhaust gases could cause fires. Keep at least 5ft. (1.5m) clearance from any combustibles or structures, including overhead.	 Los gases calientes de salida podrían causar incendios. Manténgase a una distancia mínima de 1,5m de cualquier combustible o estructura, incluyendo lugares elevados.	 Les gaz d'échappement chauds peuvent provoquer des incendies. Gardez au moins 5 pi (1,5 m) de dégagement de tout combustible ou de toute structure, y compris au-dessus.

②

NOTICE	AVISO	AVIS
 Operate, store and transport on firm level surface. •Tilting can cause fuel spillage.	 Operar, almacenar y transportar en una superficie firme y nivelada. •Inclinarlo puede causar un derrame de combustible.	 Faire fonctionner, entreposer et transporter sur une surface ferme et horizontale. •L'inclinaison peut causer un déversement de carburant.

③

	Fuel level indicator Indicador de nivel de combustible Indicateur de niveau de carburant
⚠ WARNING	
Fuel is flammable which could cause burns resulting in death or serious injury. • Turn engine off and let it cool at least 2 minutes before refueling. • Do not fill fuel above fuel level indicator. • Never add fuel to a hot or running generator.	
⚠ ADVERTENCIA	
El combustible es inflamable, lo que podría causar quemaduras resultantes en la muerte o lesiones graves. • Apague el motor y déjelo enfriar al menos 2 minutos antes de recargar combustible. • No llene el combustible por encima del indicador de nivel. • No cargue nunca combustible en un generador caliente o en funcionamiento.	
⚠ AVERTISSEMENT	
Le carburant est inflammable, ce qui peut provoquer des brûlures entraînant la mort ou des blessures graves. • Eteindre le moteur et le laisser refroidir au moins 2 minutes avant le remplissage. • Ne pas remplir au-delà de l'indicateur de niveau maximal de carburant. • Ne jamais ajouter de carburant à une génératrice chaude ou en marche.	



④

⚠ DANGER	⚠ PELIGRO	⚠ DANGER
Using a generator indoors CAN KILL YOU IN MINUTES. Generator exhaust contains carbon monoxide. This is a poison you cannot see or smell.	El uso de un generador en interiores PUEDE MATAR A UNA PERSONA EN CUESTIÓN DE MINUTOS. Los gases de escape del generador pueden contener monóxido de carbono. Este es un gas tóxico que no se ve ni se huele.	L'utilisation d'un générateur à l'intérieur présente un danger. IL PEUT VOUS TUER EN QUELQUES MINUTES. L'échappement contient du monoxyde de carbone. Ce gaz est un poison invisible et invisible.
 NEVER use inside a home or garage, EVEN IF doors and windows are open.	 Only use OUTSIDE and far away from windows, doors, and vents.	 NE JAMAIS utiliser dans un garage ou à l'intérieur, MEME avec les portes et les fenêtres ouvertes.





⑤

NOTICE	AVISO	AVIS
To prevent engine damage the spark arrester should be cleaned every 100 hours. See Operator's manual.	Para evitar daños en el motor, el supresor de chispas debe limpiarse cada 100 horas. Consulte el manual del operador.	Pour éviter d'endommager le moteur, le pare-étincelles devrait être nettoyé toutes les 100 heures. Éloignez l'échappement du moteur des structures occupées. Voir le manuel de l'utilisateur.

⑥

<p>Point engine exhaust away from all occupied structures.</p> 	<p>Mantenga los gases de escape del motor lejos de instalaciones ocupadas.</p> 	<p>Pointer l'échappement du moteur loin de toutes les structures occupées.</p> 
---	---	---





⑦

 ⚠ WARNING	 ⚠ ADVERTENCIA	 ⚠ AVERTISSEMENT
 <p>Liquid Petroleum Gas (LPG) is extremely flammable which could cause burns or fire resulting in death or serious injury. If you smell gas, close tank valve and call qualified plumber. Do not place LPG source in the path of muffler outlet.</p>	<p>El Gas Licuado de Petróleo (GLP) es extremadamente inflamable, lo que puede causar quemaduras o incendios resultantes en la muerte o lesiones graves. Si huele gas, cierre la válvula del tanque y llame a un plomero calificado. No coloque la fuente de GLP en la trayectoria de salida del silenciador.</p>	<p>Le gaz de pétrole liquide (GPL) est extrêmement inflammable et pourrait causer des brûlures ou un incendie entraînant la mort ou des blessures graves. Si vous sentez une odeur de gaz, fermez le robinet du réservoir et appelez un plombier qualifié. Ne placez pas la source de GPL dans la trajectoire de la sortie du silencieux.</p>

⑧

FOR RESIDENTS OF CALIFORNIA	PARA LOS RESIDENTES DE CALIFORNIA	POUR LES RÉSIDENTS DE LA CALIFORNIE
<p>⚠ WARNING: This product and the engine exhaust from this product can expose you to chemicals including CO, which are known to the State of California to cause cancer or cause birth defects and other reproductive harm. For more information, go to www.P65Warnings.ca.gov.</p>	<p>⚠ ADVERTENCIA: Este producto y el escape del motor de este producto pueden exponerlo a productos químicos, incluido CO, que en el estado de California son conocidos por causar cáncer o causar defectos de nacimiento u otros daños reproductivos. Para obtener más información, vaya a www.P65Warnings.ca.gov.</p>	<p>⚠ AVERTISSEMENT: Ce produit et l'échappement du moteur de ce produit peuvent vous exposer à des produits chimiques, y compris le CO, qui sont connus par l'État de Californie pour causer le cancer ou causer des malformations congénitales et autres problèmes de reproduction. Pour plus d'informations, visitez www.P65Warnings.ca.gov.</p>

⑨

 AUTOMATIC SHUTOFF - YOU MUST:	 CORTE AUTOMÁTICO - DEBE REALIZAR LO SIGUIENTE:	 ARRÊT AUTOMATIQUE - VOUS DEVEZ:
<p>MOVE GENERATOR TO AN OPEN OUTDOOR AREA. POINT EXHAUST AWAY FROM HOMES. DON'T RUN GENERATOR IN ENCLOSED AREAS (e.g. NOT IN HOUSE OR GARAGE). AIR OUT PREMISES (OPEN WINDOWS AND DOORS) BEFORE REOCCUPYING PROPERTY.</p>  <p>20 FT. (PIES) (6 m) MIN.</p>	<p>MUEVA EL GENERADOR A UN ÁREA ABIERTA AL AIRE LIBRE. APUNTE EL ESCAPE LEJOS DE LAS CASAS. NO UTILICE EL GENERADOR EN ÁREAS CERRADAS (EN CASA O EL GARAJE). VENTILE LAS INSTALACIONES (VENTANAS Y PUERTAS ABIERTAS) ANTES DE VOLVER A OCUPAR LA PROPIEDAD.</p>	<p>DÉPLACEZ LA GÉNÉRATRICE DANS UN ESPACE EXTÉRIEUR OUVERT. ÉLOIGNEZ L'ÉCHAPPEMENT DES MAISONS. NE FAITES PAS FONCTIONNER LA GÉNÉRATRICE DANS DES ZONES FERMÉES (P. EX. PAS DANS LA MAISON NI DANS LE GARAGE). AÉREZ LES LIEUX (FENÊTRES ET PORTES OUVERTES) AVANT DE RÉINTÉGRER LA PROPRIÉTÉ.</p>
<p> MOVE TO FRESH AIR AND GET MEDICAL HELP IF SICK, DIZZY OR WEAK.</p>	<p>UBÍQUESE EN UN LUGAR DONDE CORRA AIRE FRESCO Y BUSQUE AYUDA MÉDICA SI SE SIENTE MAL, MAREADO O DÉBIL.</p>	<p>ALLEZ À L'AIR FRAIS ET OBTENEZ DE L'AIDE MÉDICALE EN CAS DE MALADIE, D'ÉTOURDISSEMENT OU DE FAIBLESSE.</p>

⑩

	⚠ WARNING	⚠ ADVERTENCIA	⚠ AVERTISSEMENT
	<p>Muffler could cause burns resulting in serious injury.</p> <ul style="list-style-type: none"> •Do not touch hot parts •Avoid hot exhaust gases 	<p>El silenciador podría causar quemaduras resultando en una lesión grave.</p> <ul style="list-style-type: none"> •No toque las partes calientes •Evite los gases de escape calientes 	<p>Le silencieux pourrait causer des brûlures entraînant des blessures graves.</p> <ul style="list-style-type: none"> •Ne touchez pas les pièces brûlantes. •Évitez les gaz d'échappement chauds

FEATURES AND CONTROLS

Control Panel

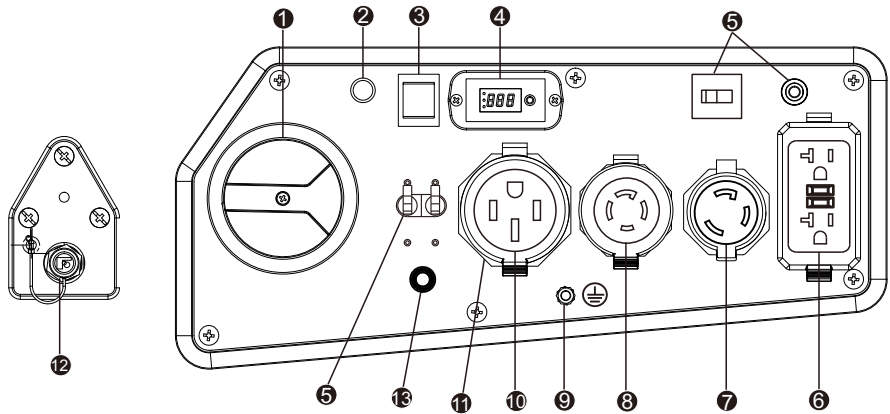

NOTICE Total power drawn from all receptacles must not exceed the data decal rating.

1. Fuel Selector Switch - Use to select and turn on gasoline or LPG fuel source. Fuel (gasoline) valve is closed when the switch is on "OFF" or "LPG" positions. Engine switch is on when the switch is on "GAS" or "LPG" positions.

2. Indicator Light - When the main fuel selector switch is turned to the GAS or LPG position, the indicator light will turn RED for up to 4 minutes (before going off). Starting the engine successfully anytime during the 4 minutes will turn the indicator light GREEN. See Indicator light-Battery Power Saving Mode section for more information.

3. Engine Start Switch - To start engine, press and hold the switch in the START (II) position, the engine will crank and attempt to start. When the engine starts, release the switch to the RUN (I) position.

4. 3-1 Data-Minder (Multi-Meter) - Push the SELECT button to show the Voltage, Hertz and running hours.

5. Circuit Breakers - The receptacles are protected by AC circuit protectors. If the generator is overloaded or an external short circuit occurs, a circuit protector may trip. If tripping occurs, disconnect all electrical loads and determine the cause before attempting to continue using the generator. Reset any tripped circuit protectors.

If multiple receptacles are used at the same time, the total current must be kept with-in the portable generator data decal rating.

6. 120V, 20A Duplex GFCI (Ground Fault Circuit Interrupter)- NEMA 5-20R
A maximum of 20 Amps current may be drawn from this duplex receptacle.

7. 120V, 30A Twist Lock - NEMA L5-30R(Not GFCI protected)
A maximum of 30 Amps current may be drawn from this receptacle.

8.120/240V, 30A Twist Lock - NEMA L14-30R(Not GFCI protected)
A maximum of 30 Amps current for 240 Volts or two independent 120 Volt loads at 30 Amps current each.

9.Ground Terminal - Consult an electrician or authority having jurisdiction for local grounding requirements.

10. 120/240V, 50A - (NEMA 14-50R) (Not GFCI protected)
A maximum of 33.33 Amps current for 240 Volts or two independent 120 Volt loads at 33.33 Amps current each.

11. Outlet Cover - Protects the receptacles from dust and debris.

12. LPG Hose Connector (Inlet: 3/8" Flare Male) - Used to connect LPG hose to generator.

13. CO Alert™ Carbon Monoxide (CO) Shutdown Indicator Light - Indicates the engine shutdown due to carbon monoxide accumulation around the generator or a CO Alert system fault occurred.

1. Location



DANGER! Engine exhaust contains carbon monoxide, a poisonous gas that could kill you in minutes. You **CANNOT** smell it, see it, or taste it. Even if you do not smell exhaust fumes, you could still be exposed to carbon monoxide gas.

- Operate portable generator only outdoors and downwind at least 20 ft. (6 m) from occupied spaces with exhaust pointed away to reduce the risk of carbon monoxide accumulating.
- Install battery-operated carbon monoxide alarms or plug-in carbon monoxide alarms with battery back-up according to the manufacturer's instructions. Smoke alarms cannot detect carbon monoxide gas.
- Do not run this portable generator inside homes, garages, basements, crawlspaces, sheds, or other partially-enclosed spaces even if using fans or opening doors and windows for ventilation. Carbon monoxide can quickly build up in these spaces and can linger for hours, even after this product has shut off.
- If you start to feel sick, dizzy, weak or your home's carbon monoxide alarm sounds, get to fresh air right away. Call emergency services. You may have carbon monoxide poisoning.

Carbon Monoxide Alarm(s)

Install carbon monoxide alarms inside your home. Without working carbon monoxide alarms, you will not realize you are getting sick and dying from carbon monoxide poisoning.

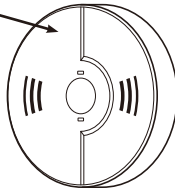

Prevent Carbon Monoxide (CO) Poisoning

Use outdoors and downwind at least 20 ft. (6 m) from any home. Point exhaust away from all homes and occupied spaces. Install CO alarms inside your home.



20 ft. (6 m) min.

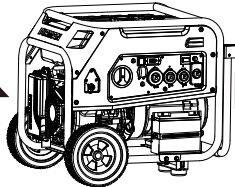

To better educate yourself about all carbon monoxide risks, go to www.takeyourgeneratoroutside.com.

OPERATION

Reduce Risk of Fire



WARNING! Exhaust heat/gases could ignite combustibles, structures or damage fuel tank causing a fire, resulting in death or serious injury.

- Keep portable generator at least 5 ft. (1.5m) from any structure, trees or vegetation over 12 in. (30 cm) in height.
- Select an outdoor site that is dry and protected from the weather. Do not move portable generator indoors to protect it from the weather.
- Do not locate the portable generator under a deck or other similar structure that may confine heat and airflow.

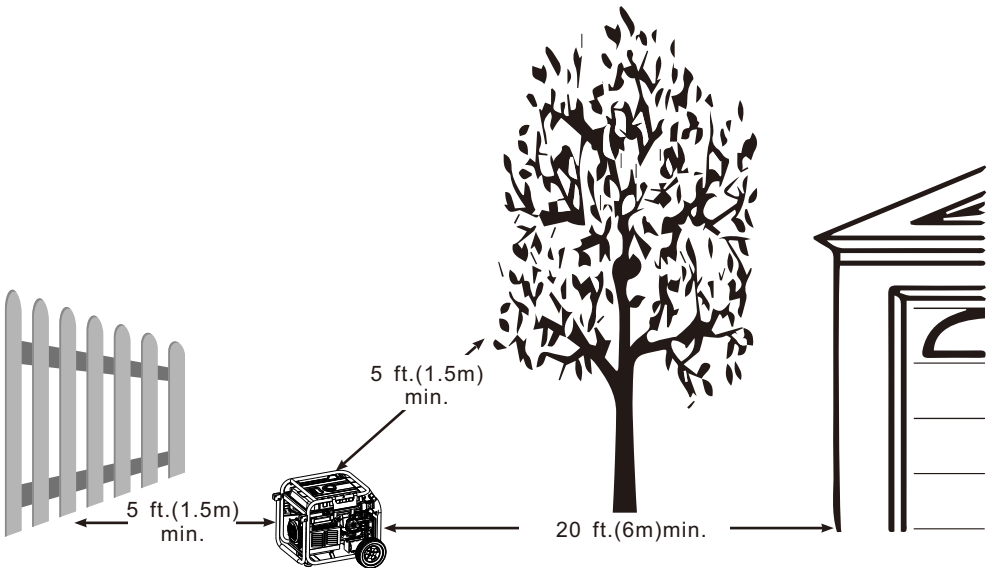

2, Oil and Gasoline / LPG

Add Engine Oil

We recommend using FIRMAN SAE 10W-30 API SJ oil for best performance. Other high-quality detergent oils (API SJ or higher) are acceptable. Do not use special additives. Ambient temperature determines the proper oil viscosity for the engine. Use the chart to select the proper oil for the outdoor temperature range expected.

NOTICE Do not attempt to crank or start the engine before it has been properly filled with the recommended type and amount of oil. Damage due to operation with no oil will void your warranty.

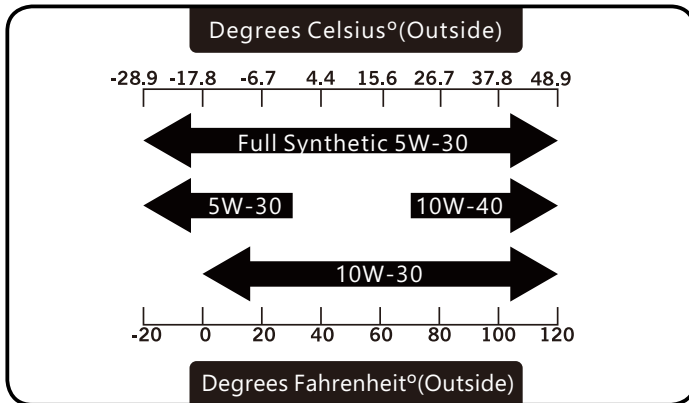

1. Place generator on a flat, level surface.
2. Clean area around oil fill and remove yellow oil fill cap/dipstick.
3. Wipe dipstick clean.

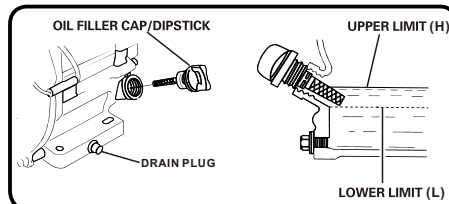
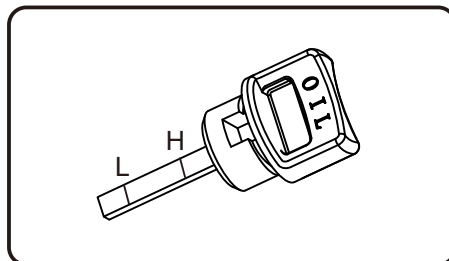

OPERATION

4. Using oil funnel, slowly pour contents of provided oil bottle into oil fill opening until oil reaches upper limit "H" mark on the dipstick. Be careful not to overfill. Overfilling could cause engine starting problems or engine damage.

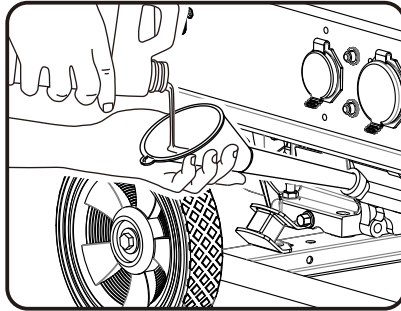

5. Replace oil fill cap/dipstick and fully tighten.

6. Oil level should be checked prior to each use or at least every 8 hours of operation. Keep oil level maintained.

Low Oil Shutdown

The portable generator is equipped with a low oil shutdown. If the oil level drops below the minimum required level, a sensor will activate an internal switch stopping the engine. If the engine shuts off and the oil level is within specifications, check to see if generator is sitting at an angle. Place portable generator on an even surface to correct this. If engine fails to start, the oil level may not be high enough to deactivate the internal low oil level switch. Make sure the sump is completely full of oil to the upper limit (H). Do not operate engine until oil level issue is corrected. Contact Firman customer service.

Add Gasoline



WARNING! Fuel and its vapors are extremely flammable which could cause burns or fire resulting in death or serious injury.

- Turn generator engine OFF and let it cool at least 2 minutes before removing fuel cap.
- Do Not refuel or move generator when engine is running.
- Move generator outdoors prior to adding or draining fuel
- Keep fuel away from any ignition sources.
- Do not overfill tank, allow space for fuel expansion.
- If any fuel spills, wait until it evaporates before starting engine
- Check and replace fuel lines, tank, cap, and fittings prior to each use if any damage or leaks are found.

Fuel must meet these requirements:

- Clean, fresh, unleaded gasoline with a minimum of 87 octane.
- For high altitude use, see Operation at High Altitude.
- Gasoline with no more than 10% ethanol is acceptable.

E10

E15

NOTICE Do not mix oil in gasoline or modify engine to run on alternate fuels not described in this manual. Use of unapproved fuels could damage engine and will not be covered under warranty.

1. Clean area around fuel fill cap, remove cap.
2. Slowly add unleaded fuel to fuel tank. Be careful not to fill above the RED fuel level indicator. This allows adequate space for fuel expansion.

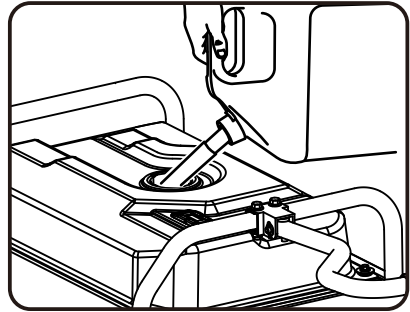
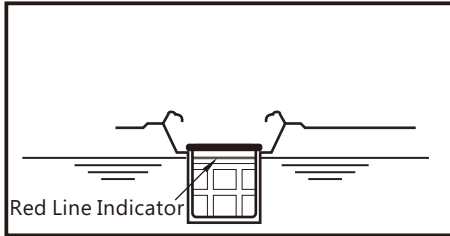

3. Install fuel cap and let any spilled fuel evaporate before starting engine.

Operation at High Altitude

At altitudes over 5,000 feet(1524 meters), a minimum 85 octane gasoline is acceptable. Engine power and generator output will be reduced approximately 3.5% for every 1000 feet (305 m) of elevation above sea level. High altitude may cause hard starting, increased fuel consumption and sparkplug fouling. To operate at high altitudes FIRMAN can provide a high altitude carburetor main jet. The alternative main jet and installation instructions can be obtained by contacting Customer Support. Installation instructions are also available in the Technical Bulletin area of the FIRMAN website www.firmanpowerequipment.com.

	439cc	Altitude
Altitude main jet 1	380717004	3000-6000Feet
Altitude main jet 2	380717005	6000-8000Feet

NOTICE Operation using an alternative main jet at elevations lower than the recommended minimum altitude can damage the engine. For operation at lower elevations, the standard main jet supplied must be used. Operating the engine with the wrong main jet may increase exhaust emissions, fuel consumption and reduce performance.

Operation at High Ambient conditions

Your Firman Power Equipment product is designed and rated for continuous operation at ambient temperatures up to 104°F (40°C). The generator may be operated at temperatures ranging from 5°F(-15°C) to 122°F(50°C) for short periods. If the generator is exposed to temperatures outside this range during storage, the generator should be brought back within this range before operation. When operated above 77°F(25°C) there may be a decrease in power. Maximum wattage and current are subject to and limited by such factors as ambient temperature, altitude, engine conditions etc.

OPERATION

Connecting LPG Fuel



WARNING! Liquid Petroleum gas (LPG) is extremely flammable which could cause burns or fire resulting in death or serious injury.

- The fuel supply line must always be shut off when the engine is not running. Failure to shut off fuel may allow fuel to leak at the generator.
- Do not place the LPG sources in the path of muffler outlet or near any ignition source. Keep a fire extinguisher near the generator all the time.
- Do not use or store LPG portable sources not in use near generator or in a building, garage or enclosed area.
- All LPG supply/ piping lines must be installed by a qualified plumber.
If you smell gas, close off all gas sources and contact a qualified plumber to inspect and repair the LPG .
- Prior to each days first use spray a soapy water solution on LPG fuel connections to check for leaks.
- Never use a gas container, LPG connector hose or LPG cylinder that appears to be damaged.
- Do not connect or disconnect the LPG source in an enclosed area.

LPG is heavier than air and can accumulate in confined / low spaces if there is a leak.

NOTICE If a fuel supply connection is necessary it must be installed in accordance with all local codes or regulations, or in the absence of local codes or regulations, in accordance with the National Fuel Gas Code (NFPA 54/ANSI Z223.1) and CSA B149.1 (Natural Gas and Propane Installation Code), as applicable. If possible the fuel supply connection should be close to the outdoor operating location. This will reduce the cost of the flexible fuel run. An approved flexible fuel line must be installed between the generator LPG Hose Connector (Inlet) and the fuel supply connection. In no case should this information be interpreted to conflict with any local, state, or national code. If in doubt, always follow local codes.

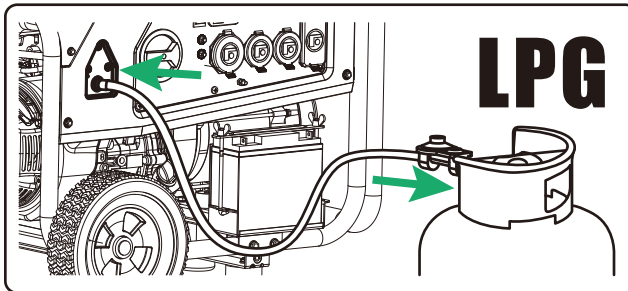

- Always keep the LPG cylinder in an upright position.
- Use only DOT LPG cylinders in vapor service with type 1, right hand ACME threads. Verify the re-qualification date on the cylinder has not expired.
- All new cylinders must be purged of air and moisture prior to filling. The purging process should be done by your propane gas supplier.

Attach the LPG regulator hose assembly (included) to the LPG hose connector (inlet) on the control panel of the generator. Tighten the nut with a 19 mm or adjustable wrench. Remove the safety plug or cap from the LPG cylinder valve. Attach the LPG regulator to the cylinder valve. Do not use a wrench to tighten LPG cylinder nut. Tighten the nut by hand clockwise to a positive stop. Using a wrench may damage LPG cylinder components.

Indicator light - Battery Power Saving Mode

This generator is equipped with an electronic module which consumes battery power. When the main fuel selector switch is turned to the GAS or LPG position, the indicator light will turn RED for up to 4 minutes (before going off). Starting the engine successfully anytime during the 4 minutes will turn the indicator light GREEN. If portable generator is not started during this 4-minute period the portable generator will switch to Battery Power Saving Mode to conserve battery life.

NOTICE Your portable generator is equipped with an internal battery charger that will properly charge the battery only when the engine is running.

The generator cannot be started in Battery Power Saving Mode. Turn main fuel selector switch to the off position and back to the GAS or LPG position to reset the RED indicator 4-minute electronic module.

3.Starting the Generator on Gasoline

1. Before starting the generator, check for loose or missing parts and for any damage which may have occurred during shipment. Ensure spark plug, muffler, fuel cap, and air cleaner are all in place.
2. Operate portable generator only outdoors and downwind at least 20 ft. (6 m) from occupied spaces with exhaust pointed away to reduce the risk of carbon monoxide accumulating.
- 3.If connected make sure the LPG cylinder knob is fully closed or disconnected.



- 4.Turn the main fuel selector switch to "GAS" position.

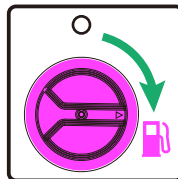

NOTICE When the main fuel selector switch is turned to the GAS position, the indicator light will turn RED for up to 4 minutes (before going off). Starting the engine successfully anytime during the 4 minutes will turn the indicator light GREEN. See Indicator light-Battery Power Saving Mode section for more information.

OPERATION

5. Disconnect all electrical loads from the generator. Never start or stop the generator with electrical devices plugged in.

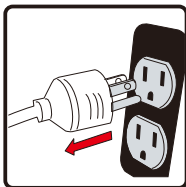

6. Move choke lever located on engine to "START" position. You do not need to choke a warm engine. (For electric start move to step (8))

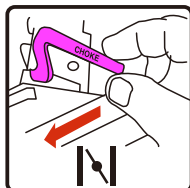

7. For recoil start only - Pull the starter cord slowly until resistance is felt and then pull rapidly to start engine.

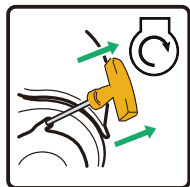

8. For electric start only - Flip the engine switch to the START (II) position for a few seconds and then release.



9. Do not over-choke. As soon as engine starts and warms up, slowly move the choke lever to the RUN position.

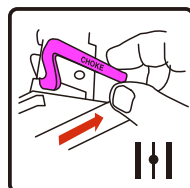

10. Allow portable generator to run at no load for a few minutes to stabilize before plugging in any electrical devices.

NOTICE If engine starts but fails to run, or if portable generator shuts down during operation, check oil level. See Low Oil Shutdown section for more information.

4. Starting the Generator on LPG

1. Before starting the generator, check for loose or missing parts and for any damage which may have occurred during shipment. Ensure spark plug, muffler, fuel cap, and air cleaner are all in place.
2. Operate portable generator only outdoors and downwind at least 20 ft. (6 m) from occupied spaces with exhaust pointed away to reduce the risk of carbon monoxide accumulating.
3. Connect the LPG hose with regulator to both LPG cylinder and portable generator LPG Hose Connector (inlet).

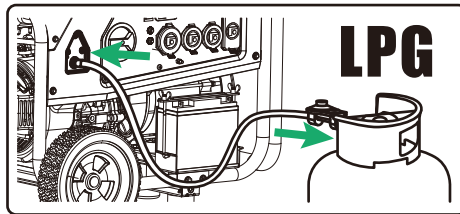

4. Fully open the LPG cylinder knob.



5. Turn the main fuel selector switch to LPG position.

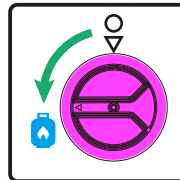

NOTICE When the main fuel selector switch is turned to the LPG position, the indicator light will turn RED for up to 4 minutes (before going off). Starting the engine successfully anytime during the 4 minutes will turn the indicator light GREEN.

See Indicator light-Battery Power Saving Mode section for more information.

OPERATION

6. Disconnect all electrical loads from the generator. Never start or stop the generator with electrical devices plugged in.

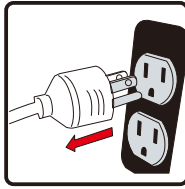

7. Move choke lever located on engine to "START" position. (For electric start move to step (11))

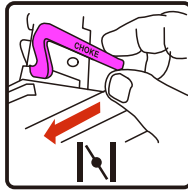

8. For recoil start only - PULL-TO-PRIME Pull the starter cord 1-2 times. Pull slowly until resistance is felt and then pull rapidly.

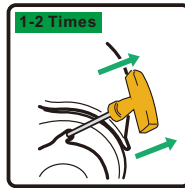

9. For recoil start only - Move the choke lever to the "RUN" position.

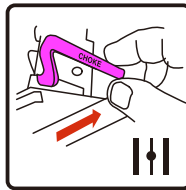

10. For recoil start only - PULL-TO-RUN Pull the starter cord slowly until resistance is felt and pull rapidly to run the portable generator.

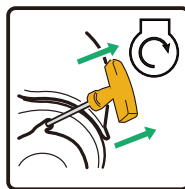

If the engine fails to start in 1-2 pulls with choke in the RUN position, move choke lever to START position and repeat the PULL-TO-PRIME step (8).

11. For electric start only - Flip the engine switch to the START (II) position for a few seconds and then release.



12. For electric start only - Move the choke lever to the RUN position.

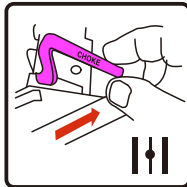

13. Allow portable generator to run at no load for a few minutes to stabilize before plugging in any electrical devices.

NOTICE If engine starts but fails to run, or if portable generator shuts down during operation, check oil level. See **Low Oil Shutdown** section for more information.

NOTICE Observing frost on LPG cylinder and regulator is common during operation and normally is not an indication of a problem. In unusual situations this frost may eventually restrict the flow of LPG gas to the generator resulting in deteriorating performance. In these rare situations it can be helpful to:

- Exchanging fuel cylinders to allow the first cylinder to warm up, repeating as necessary.
- Placing the LPG cylinder at the end of the generator near the handle, where engine fan air flows out from the generator. This air is slightly heated by air flowing over the engine.
- Do not place the LPG cylinder in the path of the muffler exhaust outlet.

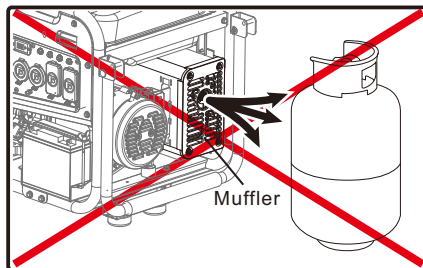

- The LPG cylinder and components can be temporarily warmed by pouring warm water over them.

OPERATION

5. Connecting Electrical Loads

This portable generator has been pretested and adjusted to handle its full capacity. The voltage is regulated using an automatic voltage regulator (AVR). Readjusting the AVR will void warranty.

The duplex receptacle is equipped with GFCI protection. The GFCI protects against electric shock that may be caused if you become a path which electricity travels to reach earth. Even with a GFCI you may feel a shock, but the GFCI cuts power quickly so an average person should not suffer any injury. Manual test GFCI while generator is running to verify internal contacts will function

- Push the test button. The reset button will pop out, which should cut power to outlet.
- Press the reset button until it locks in the depressed position. If the GFCI does not reset as described do not use the receptacles. Call Firman customer service.
- If GFCI trips while in use, reset and test the outlet. Electric cords laying on the ground with worn insulation may trip the GFCI, only use cords in good condition.

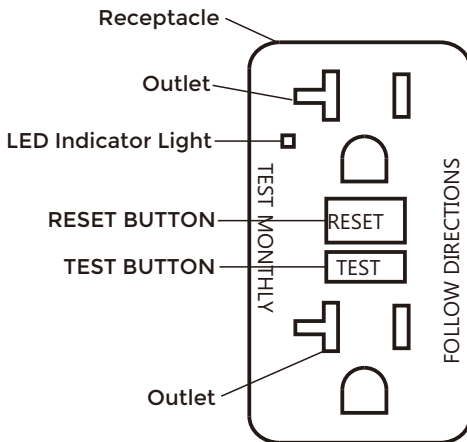

SELF-TEST OPERATION

In addition to the manual test / reset feature the GFCI receptacle tests itself periodically to confirm the GFCI electronics are functional. The indicator light will be solid green when the GFCI is powered from the generator and working correctly.

Self-test indications: If the indicator light is solid orange or flashing red a problem may exist. Press the TEST button to trip the GFCI. If unable to reset, replace the GFCI.



WARNING! Generator voltage could cause electrical shock or burn resulting in death or serious injury.

- Damaged or overloaded extension cords could overheat, arc, and burn resulting death or serious injury.
- Use a ground fault circuit interrupter (GFCI) in any damp or highly conductive area, such as metal decking.
- Do not touch bare wires or receptacles.

- Do not use generator with electrical cords which are worn, frayed, bare or otherwise damaged.
- Do not operate generator in the rain or wet weather.
- Do not run indoors to avoid wet conditions.
- Do not handle generator or electrical cords while standing in water, while barefoot, or while hands or feet are wet.
- Use listed transfer switch to prevent backfeed by isolating generator from electric utility workers.

1. Ensure circuit breaker on control panel is in the closed (on) position.
2. Start the generator with no electrical load attached.
3. Allow the engine to run for several minutes to stabilize.
4. Plug in and turn on the first item. It is best to attach the item with the largest load first.
5. Allow the engine to stabilize.
6. Plug in and turn on the next item.
7. Allow the engine to stabilize.
8. Repeat steps 5-6 for each additional item.

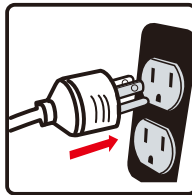

Surge Protection

There is a remote chance that voltage fluctuations may impair the proper functioning of some sensitive electronic equipment. Electronic devices, including computers and many programmable appliances may use components that are designed to operate within a narrow voltage range and may be affected by the portable generator's momentary voltage fluctuations. While there is no way to prevent all voltage fluctuations, you can take steps to protect your sensitive electronic equipment. Install a plug-in surge suppressor on the receptacles feeding your sensitive equipment. Surge suppressors come in single or multi-outlet styles. They are designed to protect against short duration voltage fluctuations.

OPERATION

CO Alert™

Carbon Monoxide (CO) Shutdown System

CO Alert automatically shuts down the engine when harmful levels of carbon monoxide accumulate around the generator or a CO Alert fault occurs. After shutdown, the CO Alert indicator light will blink for at least five minutes per the chart below.

CO Alert DOES NOT replace carbon monoxide alarms.

Install battery-powered carbon monoxide alarm(s) in your home. Don't run generator in enclosed areas.

Color	Description
Red ●●●●●	Carbon monoxide accumulated around generator. Prior to restart move generator to an open, outdoor area downwind and at least 20 ft. (6 m) from occupied spaces with exhaust pointed away. Air out premises (open windows and doors) before reoccupying property. Automatic shutoff is an indication generator was improperly located. If you start to feel sick, dizzy, weak, or your homes carbon monoxide alarm sounds while using this product, get to fresh air right away. Call emergency services. You may have carbon monoxide poisoning.
Yellow ●● ●●	CO Alert fault occurred*. See FIRMAN authorized service dealer.

*Yellow light will blink for five seconds at the startup of generator to show CO ALERT is functioning properly.

6. Stopping the generator

1. Turn off and remove all electrical loads.

Never stop the generator with electrical devices plugged in and turned on.

Never stop the engine by moving the choke to the start position.

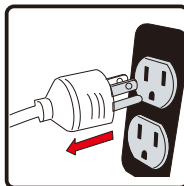

Let the generator run at no-load for one minute to stabilize internal temperatures of the engine and generator.

2. Turn the main fuel selector switch to OFF (O) position.

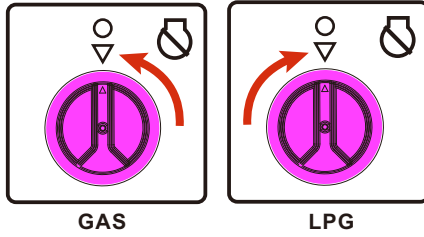

3. Fully close the LPG cylinder knob .

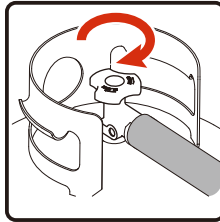

If a cover is used, do not install until unit has cooled.

NOTICE Disconnect the LPG cylinder from the generator during transportation.

Maintenance - Storage

MAINTENANCE SCHEDULE

ITEM	NOTES	Daily(Before operation)	Initial 25 hours	Every 50 hours	Every 100 hours (or annual)	Every 250 hours
Spark Plug	Check condition. Adjust gap and clean. Replace if necessary.				✓	
Engine Oil	Check oil level.	✓				
	Replace.		✓		✓	
Air Filter	Clean, replace if necessary.			✓		
Fuel	Clean fuel tank strainer. Replace if necessary.				✓	
Fuel Line	Check fuel hose for cracks or other damage. Replace if necessary.	✓				
LPG Regulator /Hose Assy.	Check for damage and leaks. Replace if necessary.	✓				
Exhaust System	Check for leakage. Retighten or replace gasket if necessary.	✓				
	Check spark arrester screen. Clean/Replace if necessary.				✓	
Engine	Check adjust valve clearance. *					✓
	Clean combustion chamber. *					✓
Fittings/ Fasteners	Check. Replace if necessary.				✓	

* To be performed by knowledgeable/experienced owner or by authorized service center.

General Recommendations

Regular maintenance will improve the performance and extend the life of the generator. See any authorized dealer for service.

The generator's warranty does not cover items that have been subjected to operator abuse or negligence. To receive full value from the warranty, the operator must maintain the generator as instructed in this manual.

Some adjustments will need to be made periodically to properly maintain your generator.

All service and adjustments should be made at least once each season. Follow the requirements in the maintenanc shedule chart above.

NOTICE Once a year you should clean or replace the spark plug and replace the air filter. New spark plugs and clean air filter assure proper fuel-air mixture and help your engine run at peak performance and last longer.

When Transporting Generator

Transport with fuel tank EMPTY or with main fuel valve in OFF position.
Do not tip generator at an angle which causes fuel to spill.
Disconnect LPG fuel hose and securely stow away.

ENGINE MAINTENANCE

To prevent accidental starting, remove and ground spark plug wire before performing any service.

Change Engine Oil

Change engine oil every 100 hours. (for a new engine, change oil after 25 hours.)
If you are using your generator under extremely dirty or dusty conditions, or in extremely hot weather change the oil more often.

CAUTION! Avoid prolonged or repeated skin contact with used motor oil. Used motor oil has been shown to cause skin cancer in certain laboratory animals. Thoroughly wash exposed areas with soap and water.



KEEP OUT OF REACH OF CHILDREN. DON'T POLLUTE. CONSERVE RESOURCES. RETURN USED OIL TO COLLECTION CENTERS.

(a) On a level surface drain oil into a suitable container by removing the drain plug and the oil filler cap while the engine is warm.

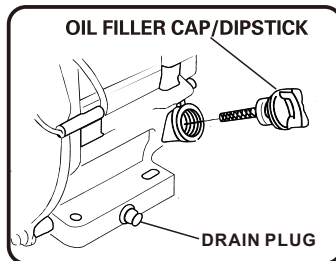

(b) Reinstall the drain plug and fill the engine with oil until it reaches the HIGH(H) level on the oil filler dipstick.

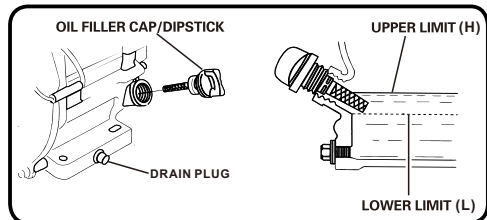
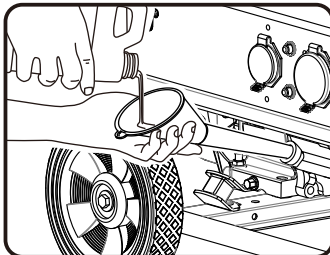

NOTICE We recommend using FIRMAN SAE 10W-30 API SJ oil for best performance. Other high-quality detergent oils (API SJ or higher) are acceptable. See *Oil and Gasoline / LPG*

Maintenance - Storage

Air Filter Maintenance

(a) Carefully remove foam air filter element and wash it with liquid detergent and water only. Squeeze dry in a clean cloth.

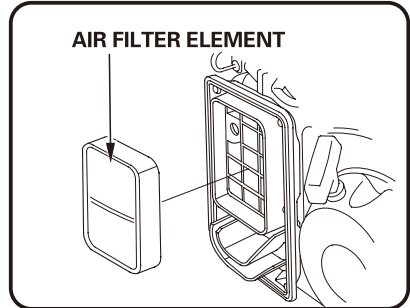
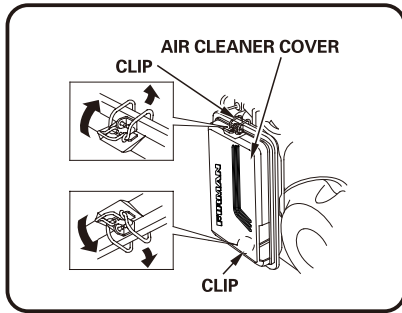

(b) Saturate foam air filter element with clean engine oil and squeeze in a clean cloth to remove excess oil.

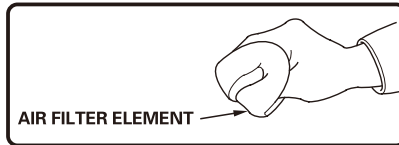

(c) Reinstall clean or new air filter element.

Spark Plug Maintenance

Changing the spark plug will help your engine start easier and run at peak performance.

(a) Remove the spark plug boot.

(b) Remove spark plug using provided wrench.

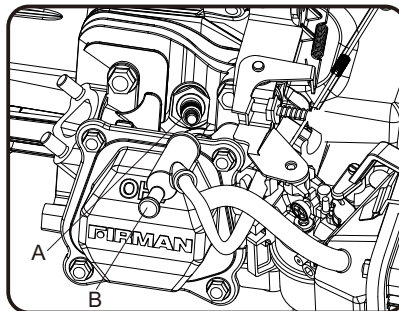

A- Spark plug
B- Spark plug boot

- (c) Inspect spark plug for damage and clean with a wire brush before reinstalling. Replace if damaged.
- (d-1) For spark plug FIRMAN P/N 330723001 - Adjust the electrode gap to 0.020 - 0.024 in. (0.5 - 0.6 mm).
- (d-2) For spark plug CHAMPION N9YC - Adjust the electrode gap to 0.028 - 0.031 in. (0.7 - 0.8 mm).
- (e) Seat spark plug in position and thread by hand to prevent cross threading.
- (f) Tighten plug with provided wrench and put the spark plug boot back on spark plug.

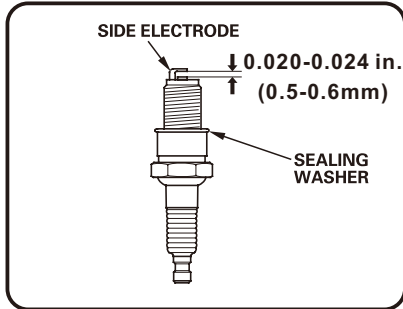

SPARK PLUG: FIRMAN P/N 330723001

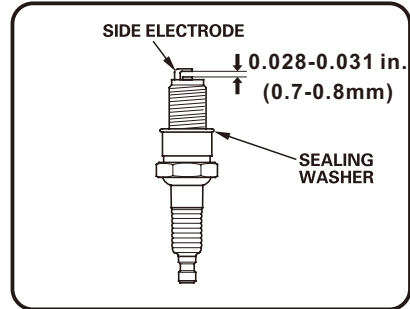

SPARK PLUG: CHAMPION N9YC

SPARK PLUG: FIRMAN P/N 330723001 or CHAMPION N9YC

Maintenance Valve Clearance

- Intake: 0.004 - 0.006 in. (0.1 - 0.15 mm)
- Exhaust: 0.004 - 0.006 in. (0.1 - 0.15 mm)

Muffler and Spark Arrester



WARNING! Contact with muffler area could cause burns resulting in serious injury.

- Do not touch hot parts.
- It is a violation of California Public Resource Code, Section 4442, to use or operate the engine on any forest-covered, brush-covered, or grass-covered land unless the exhaust system is equipped with a spark arrester, as defined in Section 4442, maintained in effective working order. Other states or federal jurisdictions may have similar laws, reference Federal Regulation 36 CFR Part 261.52.

Maintenance - Storage

Inspect Muffler and Spark Arrester

1. Inspect the muffler for cracks, corrosion, or other damage.
2. Remove the screws securing the spark arrester in place and then remove it from the muffler.

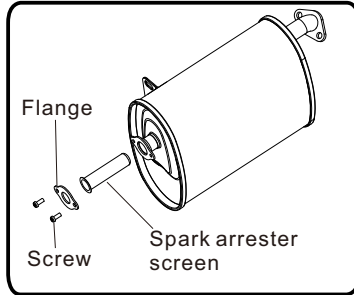

3. Carefully remove the carbon deposits from the spark arrester screen with a wire brush.

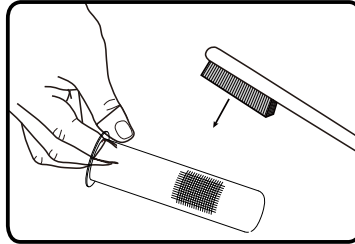

3. Replace the spark arrester if it is damaged. If replacement parts are required, make sure to use only FIRMAN original equipment replacement parts.
 4. Position the spark arrester in the muffler and attach with the screws.
- NOTICE** Failure to clean or replace spark arrester may result in decreased engine performance.

GENERATOR MAINTENANCE

Run the generator at least 30 minutes every month.

Make certain that the portable generator is kept clean and dry.

Do not expose the unit to excessive dust, dirt, moisture or corrosive vapors.

Do not insert any objects through cooling slots.

Before each use inspect underneath the generator for signs of oil or fuel. Clean any accumulated debris. Keep area around muffler free from any debris. Use a soft bristle brush to remove dirt or caked on oil. Use a damp cloth to clean all exterior surfaces.

Battery Replacement

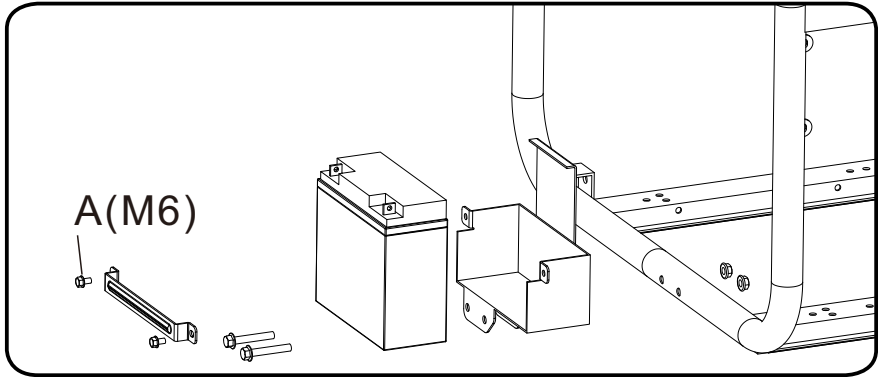

1. Remove the spark plug boot from spark plug.
2. Remove the nut and bolt from the negative(-) post first, then the positive(+) post.
3. Loosen and remove the wing nuts (A) on the battery holding bracket.
4. Remove the battery and recycle.
5. Install the new battery with the following specification:
 - 12V sealed lead acid 15AH
 - LXWXH: 7.09X2.95X6.5inch(180X75X165mm)
6. Connect the red positive (+) battery cable to the battery first.
7. Connect the black negative (-) battery cable to the battery second.
8. Cover the posts with boots provided.
9. Install the spark plug boot onto spark plug.

Battery Charging

The battery powers the starter motor and control module. This portable generator is equipped with an automatic battery charging circuit. The battery will receive charging voltage only when the engine is running. The battery will maintain a proper charge if the portable generator is used on a regular basis (about once every two weeks). If it is used less frequently, the battery should be connected to a trickle charger (not included) or battery maintainer (not included) to keep the battery properly charged. If the battery is not able to start the engine, it can be started manually only in the GAS position by pulling the engine recoil cord. If the battery voltage is extremely low, the charging circuit may not be able to re-charge the battery. In this case, the battery must be connected to a standard automotive style battery charger for re-charging before it can be used.

Long Term Storage

It is important to prevent gum deposits from forming in essential fuel system components such as the carburetor, fuel hoses or tank during storage. Alcohol-blended fuels (called gasohol, ethanol or methanol) attract moisture, which leads to separation and formation of acids during storage. Acidic gas can damage the fuel system of an engine while in storage.

When the generator set is being stored for more than one month, follow these instructions to avoid engine problems:



WARNING! Fuel and its vapors are extremely flammable which could cause burns or fire resulting in death or serious injury.

Do not store fuel near any ignition sources.

When draining fuel move generator outdoors and use a commercially available non-conductive vacuum siphon. Fuel must be drained into an approved container.

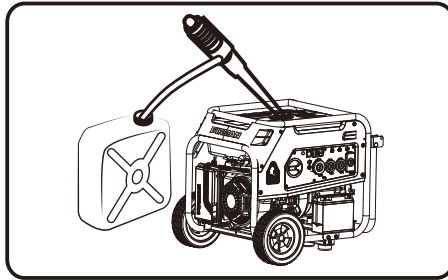

1-Treat any stored fuel with fuel stabilizer.

2-When storing generator with gasoline in fuel tank, operate the engine for 5-10 minutes to circulate treated fuel into fuel lines and carburetor before shutdown.

3- There is no need to drain gasoline from the generator fuel tank if fuel stabilizer is added.

4-FUEL STARVATION: If you elect to drain fuel tank move generator outdoors. Once fuel tank is drained turn main fuel selector switch to GAS position. Start and run the portable generator outdoors until engine stops from lack of gasoline. This will drain remaining gasoline from tank, fuel lines, and carburetor.

5-Always turn main fuel selector switch to OFF position prior to storage.

6-Allow the portable generator to cool before cleaning and storage.

7-Change oil .

8-Remove spark plug boot and spark plug. Pour about one teaspoon of engine oil through the spark plug hole, then slowly pull the recoil starter several times to distribute the oil in the cylinder. Reinstall the spark plug and attach the spark plug boot. Pull recoil slowly until resistance is felt. This will close the valves so no moisture enters the engine cylinder.

9-Cover the portable generator and store in a clean, dry place out of direct sunlight and away from any ignition sources.

Any damage or hazards caused by using improper fuel, improperly stored fuel, and/or improperly formulated stabilizers, are not covered by manufacturer's warranty.

Do not store gasoline from one season to another season.

Troubleshooting - Specifications

Problem	Cause	Correction
Engine is running, but no AC output is available.	<ol style="list-style-type: none"> 1. Circuit breaker is open. 2. Fault in generator. 3. Poor connection or defective cord set. 4. Connected device is bad. 	<ol style="list-style-type: none"> 1. Reset circuit breaker. 2. Contact authorized service facility. 3. Check and repair. 4. Connect another device that is in good condition.
Engine runs good at no-load but “bogs down” when loads are connected.	<ol style="list-style-type: none"> 1. Short circuit in a connected load. 2. Engine speed is too slow. 3. Shorted generator circuit. 4. Clogged or dirty fuel filter. 	<ol style="list-style-type: none"> 1. Disconnect shorted electrical load. 2. Contact authorized service facility. 3. Contact authorized service facility. 4. Clean or replace fuel filter.
Engine will not start; starts and runs rough or shuts down when running.	<ol style="list-style-type: none"> 1. Fuel selector switch set to OFF (O) position. 2. The indicator light is OFF or flashing red. 3. Low oil level. 4. Dirty air cleaner. 5. Out of gasoline. 6. Stale gasoline. 7. Spark plug wire not connected to spark plug. 8. Bad spark plug. 9. Water in gasoline. 10. Flooded. 11. Excessively rich fuel mixture. 12. Clogged or dirty fuel filter. 13. Starting battery may have insufficient charge. 14. Out of LPG. 15. LPG cylinder knob is not open. 16. Out of battery power. 	<ol style="list-style-type: none"> 1. Set fuel selector switch to “GAS” or “LPG” position. 2. Must have solid red indicator light to be able to start the engine. 3. Fill crankcase to proper level or place generator on level surface. 4. Clean or replace air cleaner. 5. Fill fuel tank with gasoline. 6. Drain fuel tank and carburetor; fill with fresh gasoline. 7. Connect wire to spark plug. 8. Replace spark plug. 9. Drain gas tank and carburetor; fill with fresh gasoline. 10. Wait 5 minutes and re-crank engine. 11. Contact authorized service facility. 12. Clean or replace fuel filter. 13. Check battery output and charge battery as necessary. 14. Replace LPG cylinder. 15. Fully open LPG cylinder knob . 16. Start Engine in “GAS” position. Charge or replace battery.
Engine lacks power.	<ol style="list-style-type: none"> 1. Load is too high. 2. Dirty air filter. 3. Clogged or dirty fuel filter. 4. Clogged spark arrester. 	<ol style="list-style-type: none"> 1. Don't Overload Generator 2. Replace air filter. 3. Clean or replace fuel filter. 4. Clean or replace spark arrester.
Engine “hunts” or falters.	<ol style="list-style-type: none"> 1. Carburetor is running too rich or too lean. 2. Clogged or dirty fuel filter. 	<ol style="list-style-type: none"> 1. Contact authorized service facility. 2. Clean or replace fuel filter.
Engine shuts down when running.	<ol style="list-style-type: none"> 1. Out of gasoline or LPG. 2. Dirty air cleaner. 3. Low oil level. 	<ol style="list-style-type: none"> 1. Fill fuel tank with gasoline or replace LPG cylinder . 2. Clean or replace air cleaner. 3. Fill crankcase to proper level or place generator on level surface.
Engine shuts down and yellow CO fault light blinking.	<ol style="list-style-type: none"> 1. CO system fault 	<ol style="list-style-type: none"> 1. Contact authorized FIRMAN service facility.

For all other issues, contact authorized dealer or Firman customer service.

Troubleshooting - Specifications

SPECIFICATIONS

Model	H08052		
Starting Watts	10000(GASOLINE)/9050(LPG)		
Running Watts*	8000(GASOLINE)/7250(LPG)		
Rated AC Voltage	120/240V		
Rated Frequency	60Hz		
Phase	Single		
Voltage Regulator	AVR		
Power Factor	1		
Alternator Type	Brushed		
Engine	FIRMAN		
Engine Type	Single Cylinder, 4-Stroke OHV Air Cooled		
Displacement	439cc		
Low Oil Shutdown	Yes		
Ignition System	Breakless Ignition Type, Flywheel Magneto		
Starting System	Recoil/Electric Start		
Fuel	Unleaded Automotive Gasoline/LPG		
Capacity Fuel Tank	8.0 U.S. Gallons (30.3L)		
Lubricating Oil Capacity	37.2 oz (1.1L)		
Carburetor Type	Float		
Air Cleaner	Polyurethane Type		
P.T.O. Shaft Rotation	Counter Clockwise (Facing P.T.O.)		
Oil Type	See "Add Engine Oil" Section		
AC Grounding System	Neutral Bonded To Frame		
LPG fuel consumption	No Load	Half Load	Full Load
	15.6ft ³ /hr(1.6L/hr) 39,000 BTU/h (11,429 W)	33ft ³ /hr(3.4L/hr) 82,500 BTU/h (24,176 W)	54.6ft ³ /hr(5.7L/hr) 136,500 BTU/h (40,000 W)

*Generator certified in accordance with CSA (Canadian Standards Association) standard C22.2No. 100-14, Motors and Generators and complies with PGMA (Portable Generator Manufacturers' Association) standard ANSI/PGMA G300-2018, Safety and Performance of Portable Generators.

PARTS DIAGRAM AND PART LIST
H08052 PARTS DIAGRAM

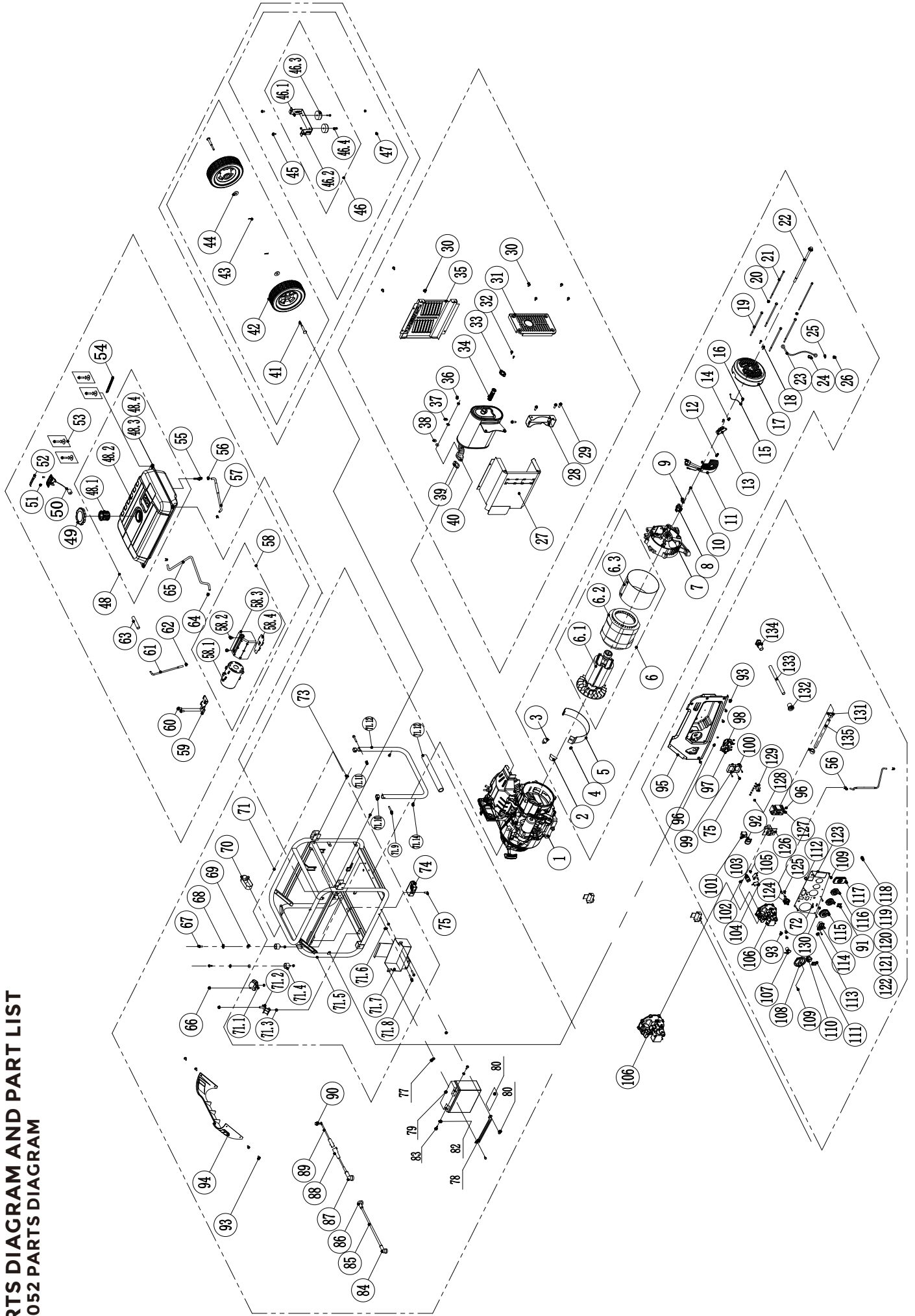

439cc DUAL FUEL ENGINE PARTS DIAGRAM

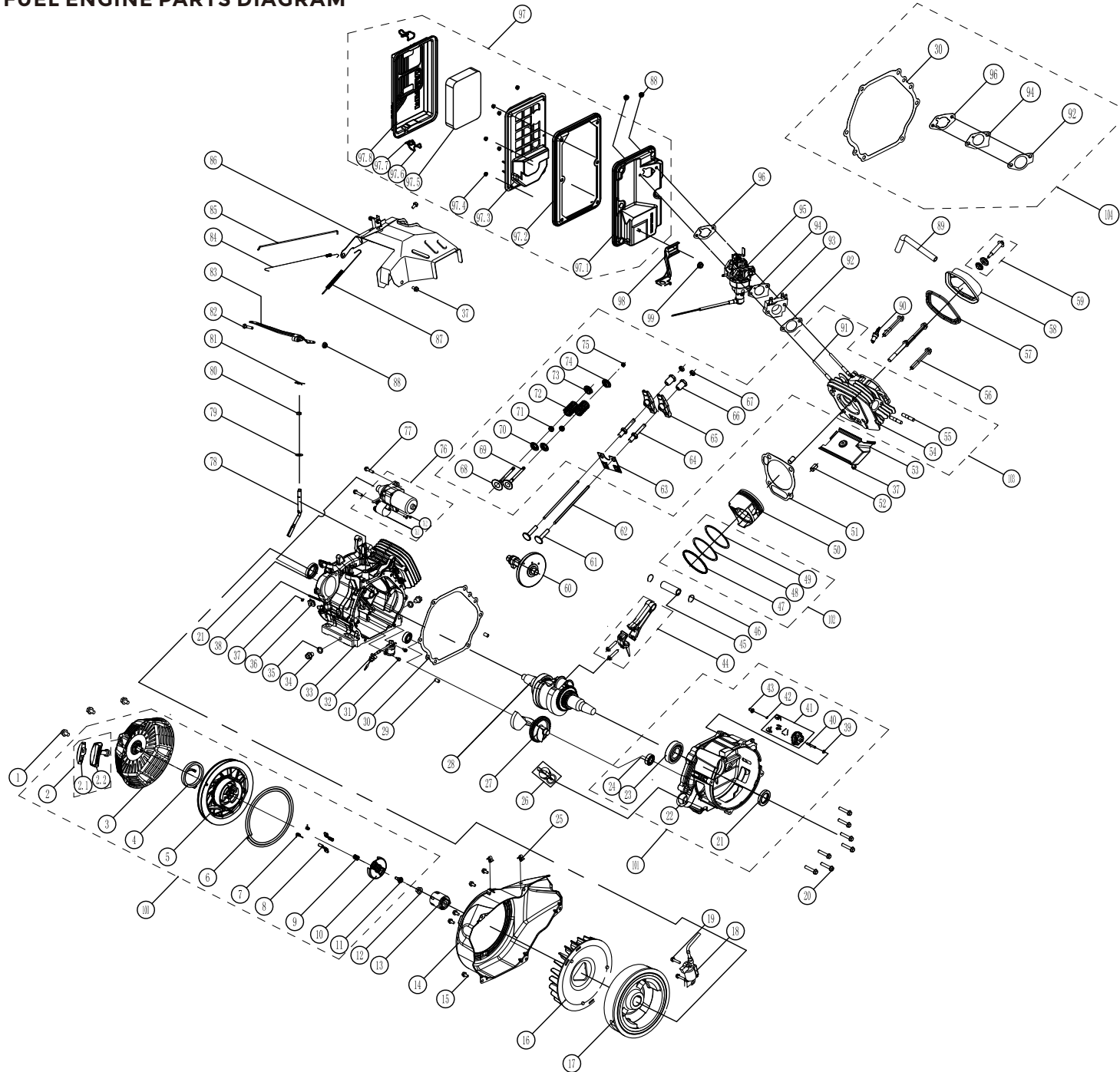

Parts Diagrams - Parts Lists - Wiring Diagram

H08052 Portable Generator

NO.	Part Number	Description	Qty.	NO.	Part Number	Description	Qty.
1	375718300	Engine Subassembly	1	46.2	357713538	Support Leg	1
2	357713501	Rubber Cap B	1	46.3	336713557	Rubber, Support	2
3	357713524	Rubber Cap A	1	46.4	336713561	Flange Bolt M6×25	2
4	336713528	Flange Bolt M6×8	1	47	336713558	Nut M8	2
5	357713573	Generator Wind Shield	1	48	357713579	Fuel Tank Assy.	1
6	380413501	Rotor And Stator Set	1	48.1	336713806	Fuel Filter, Wire Mesh	1
6.1	380713535	Rotor Assy	1	48.2	357713711	Fuel Tank	1
6.2	380713536	Stator Assy	1	48.3	336713542	Grommet, Fuel Tank	4
6.3	380713503	Stator Cover	1	48.4	357713600	Washer Tank Buffer	4
7	357713506	Generator End Cover	1	49	336713549	Fuel Cap	1
8	357713507	Carbon Brush Assembly	1	50	357713578	Fuel Gauge Assy.	1
9	336713525	Carbon Brush Holder	1	51	336713546	Screw M5×10	2
10	357713563	Bolt & washer Assemblies	1	52	336713547	Fuel Gauge Display	1
11	380713504	AVR	1	53	393713018	Bolt M6×20	4
12	336713519	Flange Bolt M5×16	2	54	317713577	Clip	1
13	336713523	Terminal Block	1	55	336713807	Tank Fitting With Filter	1
14	336713520	Bolt M5×16	2	56	330713508	Clamp	4
15	336713522	Ground Wire	1	57	380427005	Hose, fuel 1	1
16	336713519	Flange Bolt M5×16	1	58	380428300	Carbon Canister Assy	1
17	357713509	Generator End Cover Cap	1	58.1	336713637	Carbon Canister	1
18	336718309	Flange Bolt M5×12	2	58.2	380713003	Flange Bolt M6×6	2
19	380713506	Flange Bolt M6×200	4	58.3	336713636	Carbon Canister Shield	1
20	336713577	Nut M5	2	58.4	336713639	Carbon Canister Bracket	1
21	380713507	Side Cover Bolt M5×229	2	59	336713638	Carbon Canister Holder	1
22	380713508	Flange Bolt M10×285	1	60	393713016	Flange. Bolt M8×16	2
23	336713514	Ground Wire	1	61	380713533	Vapor Hose 2	1
24	336718301	Flange Bolt M6×12	1	62	330713509	Clip (Ø8.7×8)	1
25	336713516	External Star Washer Ø6	1	63	357713546	Sleeve	1
26	336713517	Nut M6	4	64	336713540	Clamp Ø8×6	2
27	357713523	Protector, muff., back	1	65	380713532	Vapor Hose 1	1
28	357713515	Holder, muff	1	66	357713531	Nut M10	2
29	336713531	Flange Bolt M8×20	4	67	357713584	Flange Bolt M8×35	2
30	336718302	Flange Bolt M6×12	7	68	336713509	Lock Washer Ø8	2
31	357713516	Protector, Muff., side	1	69	375718301	Washer	2
32	336713538	Screw & washer Assy M5×14	2	70	336713691	Hose Holder	1
33	357713517	Holder, Spark Arrester	1	71	380417006	Frame	1
34	336713536	Arrester, Spark	1	71.1	357713532	Isolator 2	1
35	357713518	Protector, Muff., Front	1	71.2	357713533	Isolator 1	1
36	336713534	Nut M8	2	71.3	336718318	Nut M8	4
37	336713509	Lock Washer Ø8	2	71.4	357713585	Motor Mount	2
38	336713533	Flat Washer Ø8	2	71.5	357713583	Frame	1
39	357713520	Gskt., ext.	1	71.6	336713558	Nut M8	2
40	380713538	Muff., assy.	1	71.7	375715002	Battery Holder	1
41	357713535	Axle Comp	2	71.8	357713527	Flange. Bolt M8×50	2
42	357713592	Wheel	2	71.9	357713527	Flange. Bolt M8×50	2
43	357713536	Lock Pin	2	71.10	380427006	Plug	2
44	357713514	Washer Ø10	2	71.11	380417008	Nut M8	2
45	336713559	Flange. Bolt M8×16	2	71.12	357713597	Handle	1
46	357413506	Support Leg Assembly	1	71.13	336713841	Red Boot	1
46.1	336718314	Nut M6	2	71.14	380427008	Cushion	2

Parts Diagrams - Parts Lists - Wiring Diagram

NO.	Part Number	Description	Qty	NO.	Part Number	Description	Qty
72	336718368	Screw&washer M3×6	4	122	336713516	External Star Washer Ø6	1
73	375718302	Flange Bolt M8×12	2	123	380417005	Control Panel Assy	1
74	392428300	CO Module	1	124	336713824	Fuel Valve Comp.	1
75	336713565	Screw M5×14	5	125	375718320	Screw&washer Assy M4×8	2
76	380427007	Fuel Hose 2	1	126	380713518	Receptacle 14-50R	1
77	336718314	Nut M6	2	127	357713588	5-20R Duplex GFCI	1
78	393713035	Battery Pressure Plate	1	128	380713526	Circuit Breaker Amp 30A	1
79	357713553	Battery	1	129	330713594	AC 20A Breaker	1
80	336718329	Flange. Bolt M6×15	3	130	336755002	Indicator Light(CO)	1
81	375728300	Grommet	1	131	336713835	Clamp	2
82	336713578	Nut M5	2	132	357713545	Grommet	1
83	357713569	Screw&washer M5×10	2	133	357713546	Sleeve	1
84	336713841	Red Boot	1	134	357713548	Grommet	1
85	357713556	Battery Red Cable +	1	135	357713591	LPG Hose	1
86	336713611	Boot,Starter	1				
87	336713842	Black Boot	1				
88	336713693	Battery Cable(female 180mm)	1				
89	357713607	Battery Cable(male 180mm)	1				
90	336713528	Flange Bolt M6×8	1				
91	380727007	Cover	1				
92	392758302	Cover	1				
93	336718302	Flange Bolt M6×12	11				
94	357713582	Plastic Front Cover	1				
95	357713590	Control Box	1				
96	336718324	Nut M4	8				
97	336713601	Receptacle L14-30R	1				
98	336713583	Receptacle L5-30R	1				
99	336718319	Control Module	1				
100	336713818	Charger	1				
101	380713524	Circuit Breaker 33A	1				
102	380417007	Tapping Screw St2.9×28	2				
103	336713821	Micro Switch 1	1				
104	336713822	Micro Switch 2	2				
105	336713819	Tapping Screw St2.9×19	2				
106	375418300	Main Regulator Assy.	1				
107	336713826	LPG Inlet Cover	1				
108	336713815	Fuel Selector Switch	1				
109	330713582	Screw&washer M4×14	6				
110	336713827	Switch	1				
111	336755004	Switch Cover	1				
112	336755005	Circuit Breaker Cover	1				
113	336713828	Indicator Light	1				
114	357713586	Multi Meter	1				
115	336713574	Outlet Cover TT-30R	1				
116	336713573	Outlet Cover L5-30R	2				
117	357713541	Outlet Cover 5-20R GFCI	1				
118	357713542	Bolt M6×22	1				
119	357713543	Nut M6	2				
120	336713512	Lock Washer Ø6	2				
121	336713513	Washer Ø6	4				

Parts Diagrams - Parts Lists - Wiring Diagram

FIRMAN 439cc Dual Fuel Engine

NO.	Part Number	Description	Qty.
1	336718308	Flg. Bolt M6×8	3
2	357723577	Grip, starter	1
2.1	336728300	Handle Core	1
2.2	336728301	Recoil Starter Knob	1
3	357723579	Case Comp.,recoil Starter	1
4	357723580	Spring,starter Return	1
5	357723582	Pulley, recoil Starter	1
6	393723006	Cord	1
7	336723589	Spring, patchet	2
8	336723590	Patchet, starter	2
9	336723592	Clip Sprg., pawl Guide	1
10	336723591	Pawl Guide	1
11	336723593	Screw, pawl Guide	1
12	357723571	Nut, Shaft	1
13	357723572	Pulley, starter	1
14	357723570	Fan Cover Comp	1
15	336718302	Flg. Bolt M6×12	5
16	380723511	Cooling Fan	1
17	380723519	Flywheel Comp	1
18	367728300	Ignition Coil	1
19	336718311	Flg. Bolt M6×29	2
20	357723516	Flg. Bolt M8×40	7
21	357723515	Seal, Oil	2
22	357723514	Cover, crankcase	1
23	357723506	Bearing	1
24	357723505	Bearing	2
25	375718321	Wire Clip	2
26	357723513	Oil Dipstick Assy	1
27	357723507	Balance Shaft	1
28	380723501	Crankshaft	1
29	336723501	Locating Pins	2
30	357723512	Gasket, Crankcase	1
31	336723526	Flg. Bolt M6×15	2
32	357723503	Sensor, Engine Oil	1
33	380723518	Crankcase Comp.	1
34	357723501	Bolt, Drain Plug	2
35	357723502	Washer, drain Bolt	2
36	336728303	Sheath, wire	1
37	336718301	Flg. Bolt M6×12	4
38	330723528	Wire Clip	1
39	336723595	Inner Washer, gear	1
40	357723586	Gov., gear Shaft	1
41	357723585	Gear, Governor	1
42	336723597	Clip, Governor Gear	1
43	357723584	Bushing, Governor Gear	1
44	357723517	Rod, Connecting	1
45	357723519	Pin, Piston	1
46	357723518	Clip, Piston Pin	2
47	380723503	Ring, oil	1
48	380723504	Ring, Second Piston	1
49	380723505	Ring, first Piston	1
50	380723502	Piston	1
51	375717006	Gasket, cyl. head	1
52	357723544	Locating Pins(φ12×20)	2
53	357723521	Air Guide Lower	1
54	375717007	Cylinder Head	1
55	357723528	Exhaust Valves Stud Bolt	2
56	357723530	Flg. Bolt M10×80	4

NO.	Part Number	Description	Qty.
57	357723525	Gasket, Cylinder Head Cover	1
58	357723526	Cover Subassembly, Cylinder Head	1
59	357723527	Bolt	1
60	357723508	Camshaft Assy.	1
61	357723543	Tappet, Valve	2
62	357723542	Push Rod	2
63	357723538	Plate Subassembly, Lifter Stopper	1
64	336723537	Bolt, Valve Adjusting	2
65	357723532	Rocker, Valve	2
66	336723529	Nut Valve Adjusting	2
67	336723528	Nut, Valve Lock	2
68	380723507	Valve, in. take	1
69	380723508	Valve, Exhaust	1
70	357723537	Retainer, Valve	2
71	357723536	Oil Seal, valve	2
72	357723535	Spring, valve	2
73	357723533	Retainer, Intake Valve	1
74	357723534	Retainer, Exhaust Valve	1
75	357723531	Rotor, Valve	1
76	380723512	Starter Motor Assembly	1
76.1	375418302	Relay Assy	1
76.2	336713519	Flange. Bolt M5×16	2
77	357713584	Flg. Bolt M8×35	2
78	357723567	Shaft, Governor Arm	1
79	336723564	Washer 8.2×17×0.8	1
80	336718312	Seal, Oil	1
81	357723565	Pin, Shaft	1
82	336723567	Bolt, governor Arm	1
83	357723564	Arm, Governor	1
84	357723562	Spring, Throttle Valve Returning	1
85	357723563	Rod, Governor	1
86	357723560	Wind Guide, Top	1
87	357723561	Spring, governor	1
88	336713517	Nut M6	3
89	357723529	Breather Tube	1
90	330723001	Spark Plug	1
91	357723548	Stud, Intake	2
92	357723549	Gskt., insulator	1
93	357723550	Plate, Carburetor Insulator	1
94	357723551	Gasket, Carburetor	1
95	380723515	Carburetor	1
96	357723554	Gasket, Air Cleaner	1
97	357423502	Air Cleaner Assy	1
97.1	357723555	Elbow, Air Cleaner	1
97.2	393718310	Seal	1
97.3	357723556	Clapboard	1
97.4	357713558	Nut M5	6
97.5	357723558	Element, Air Cleaner	1
97.6	393728305	Lock I	1
97.7	393728306	Lock II	1
97.8	357723559	Cover, Air Cleaner	1
98	357713577	Air Cleaner Bracket	1
99	336718314	Nut M6	1
100	375418307	Starter	1
101	375418303	Crankcase Cover	1
102	375418304	Ring Assy	1
103	375418305	Cylinder Head Assy	1
104	375418306	Gasket Assy	1

Parts Diagrams - Parts Lists - Wiring Diagram

Wiring Diagram

	SM1	SM2	SM3	SM4	LPG CUT SOLENOID	FUEL CUT SOLENOID
LPG	OFF	ON	a-b	a-b	work	work
OFF	OFF	OFF	a-c	a-c	un-work	un-work
GASOLINE	ON	OFF	a-b	a-b	un-work	un-work

B	BLACK	Br	BROWN
Y	YELLOW	B/W	BLACK WHITE
L	BLUE	W/G	WHITE GREEN
G	GREEN	G/Y	GREEN YELLOW
R	RED	W/L	WHITE BLUE
W	WHITE	OR	ORANGE

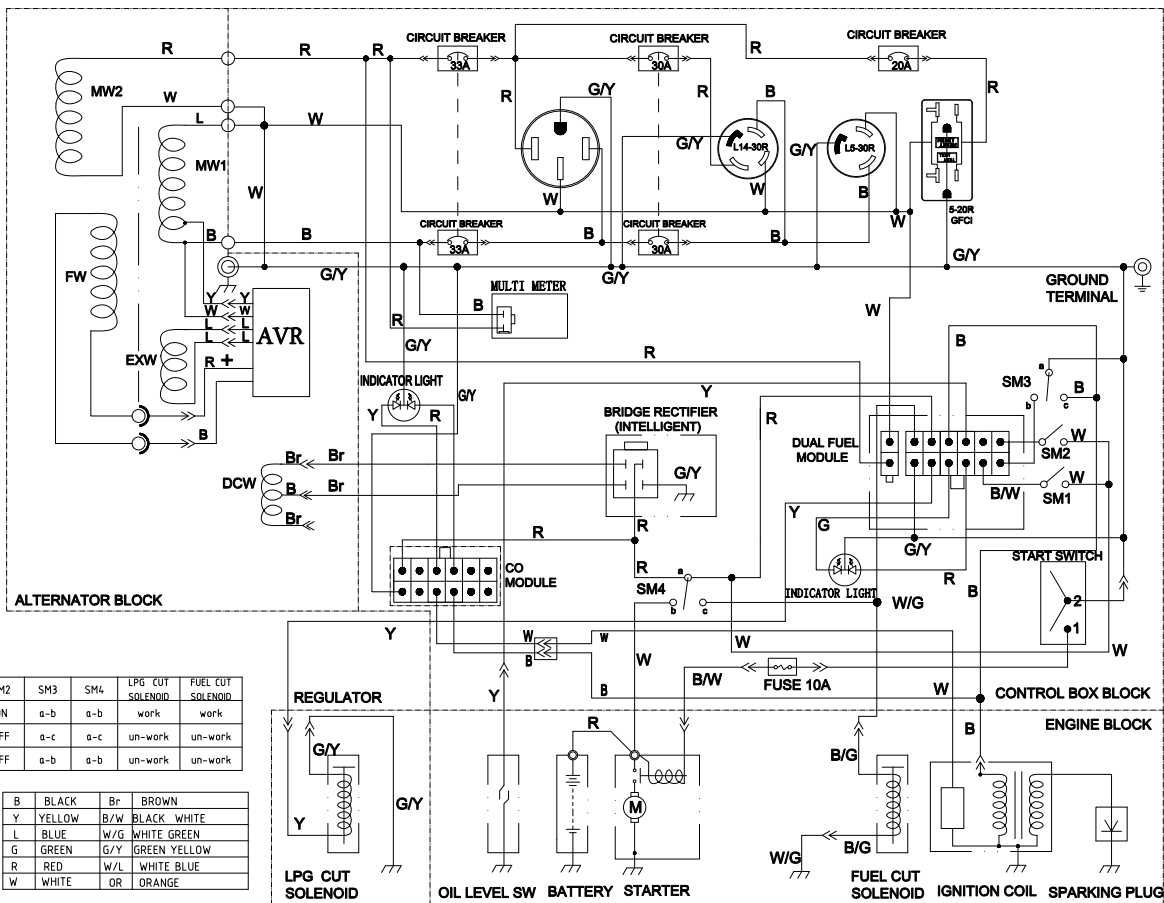

SERVICE INFORMATION CONTACT FIRMAN PRODUCT SERVICE DEPARTMENT AT 1-844-347-6261 or at www.firmanpowerequipment.com to obtain warranty service information or to order replacement parts or accessories.

HOW TO ORDER REPLACEMENT PARTS

Even quality-built equipment such as this electric generator may need occasional replacement parts to maintain it in good condition over the years. To order replacement parts, please give the following information:

- Model No. Rev. Level and Serial No. found on the Data Decal.
- Parts number or numbers as shown in the Parts List section.
- A brief description of the trouble with the generator.

FIRMAN Three (3) Year Limited Warranty Warranty Qualifications

Register your product using the QR code provided or at www.firmanpowerequipment.com. FIRMAN will also register the warranty upon receipt of your Warranty Registration Card and a copy of your sales receipt from one of FIRMAN's retail locations as proof of purchase. Please submit your warranty registration and your proof of purchase within ten(10) days of the date of purchase.



Repair/Replacement Warranty

FIRMAN warrants to the original purchaser that the mechanical and electrical components will be free of defects in material and workmanship for a period of one(1) year(parts and labor) and three(3) years (parts and technical support) from the original date of purchase 90 days [parts and labor] and 180 days [parts] for commercial & industrial use. Transportation charges on product submitted for repair or replacement under this warranty are the sole responsibility of the purchaser . This warranty only applies to the original purchaser and is not transferable.

Do Not Return the Unit to the Place of Purchase

Contact the FIRMAN Service Center and FIRMAN will troubleshoot any issue via phone or e-mail. If the problem is not corrected by this method, FIRMAN will, at its option, authorize evaluation, repair or replacement of the defective part or component at a FIRMAN Service Center. FIRMAN will provide you with a case number for warranty service. Please keep it for future reference. Repairs or replacements without prior authorization, or at an unauthorized repair facility, will not be covered by this warranty.

Warranty Exclusions

This warranty does not cover the following repairs and equipment.

Normal Wear

Your product needs periodic parts and service to perform well. This warranty does not cover repair when normal use has exhausted the life of a part or the equipment as a whole.

Service - Warranty

Installation, Use and Maintenance

This warranty will not apply to parts and/or labor if your product is deemed to have been misused, neglected, involved in an accident, abused, loaded beyond the generator's limits, modified, installed improperly or connected incorrectly to any electrical component. Normal maintenance is not covered by this warranty.

Other Exclusions

This warranty excludes:

- cosmetic defects such as paint, decals, etc.
- wear items
- accessory parts
- failures due to acts of God and other force majeure events beyond the manufacturer's control
- problems caused by parts that are not original FIRMAN parts
- units used for prime power in place of existing utility power where utility is present or in place of utility power where utility power service does not normally exist.

Limits of Implied Warranty and Consequential Damage

FIRMAN disclaims any obligation to cover any loss of time, use of this product, freight, or any incidental or consequential claim by anyone from using this product. THIS WARRANTY IS IN LIEU OF ALL OTHER WARRANTIES, EXPRESS OR IMPLIED, INCLUDING WARRANTIES OF MERCHANTABILITY OR FITNESS FOR A PARTICULAR PURPOSE.

A unit provided as an exchange will be subject to the warranty of the original unit. The length of the warranty governing the exchanged unit will remain calculated by reference to the purchase date of the original unit.

This warranty gives you certain legal rights which may change from state to state. Your state may also have other rights you may be entitled to that are not listed within this warranty.

Contact Information

You may contact FIRMAN at:

Address

Firman Power Equipment Inc.
Attn: Customer Service
8644 W. Ludlow Dr.
Peoria, AZ 85381
www.firmanpowerequipment.com

We are FIRMAN POWER - And we are here for you.

FIRMAN POWER EQUIPMENT INC. Emission Control System Warranty

CALIFORNIA AND FEDERAL EXHAUST AND EVAPORATIVE EMISSIONS CONTROL WARRANTY STATEMENT

YOUR WARRANTY RIGHTS AND OBLIGATIONS

The California Air Resources Board, US Environmental Protection Agency ("US EPA") and FIRMAN POWER EQUIPMENT INC. (FIRMAN) are pleased to explain the emissions control systems warranty on your 2022-2023 or later Small Off-Road Engine ("SORE") and engine powered equipment. In California, new equipment that use small off-road engines must be designed, built and equipped to meet the State's stringent anti-smog standards. FIRMAN must warrant the emissions control systems on your SORE and engine powered equipment for the periods of time listed below provided there has been no abuse, neglect or improper maintenance of your small off-road engine or equipment leading to the failure of the emissions control system. Your emissions control system may include parts such as the carburetor or fuel-injection system, the ignition system, catalytic converter, fuel tanks, fuel lines (for liquid fuel and fuel vapors), fuel caps, valves, canisters, filters, clamps and other associated components. Also included may be hoses, belts, connectors, and other emission-related assemblies.

Where a warrantable condition exists, FIRMAN will repair your SORE and engine powered equipment at no cost to you including diagnosis, parts and labor.

MANUFACTURER'S WARRANTY COVERAGE:

The exhaust and evaporative emissions control system on your small off-road engine and engine powered equipment is warranted for two years. If any emissions-related part on your small off-road engine and engine powered equipment is defective, the part will be repaired or replaced by FIRMAN.

OWNER'S WARRANTY RESPONSIBILITIES:

As the SORE and engine powered equipment owner, you are responsible for the performance of the required maintenance listed in your operator's manual. FIRMAN recommends that you retain all receipts covering maintenance on your SORE and engine powered equipment, but FIRMAN cannot deny warranty coverage solely for the lack of receipts or for your failure to ensure the performance of all scheduled maintenance.

As the SORE and engine powered equipment owner, you should however be aware that FIRMAN may deny you warranty coverage if your small off-road engine or engine powered equipment or a part has failed due to abuse, neglect, or improper maintenance or unapproved modifications.

You are responsible for presenting your small off-road engine and engine powered equipment to a FIRMAN distribution center or service center as soon as the problem exists. The warranty repairs shall be completed in a reasonable amount of time, not to exceed 30 days.

If you have any questions regarding your warranty rights and responsibilities, you should contact FIRMAN at 1-844-347-6261 or support@firmanpowerequipment.com.

FIRMAN Emission Control Defects Warranty Provisions

The warranty period begins on the date the engine/equipment is delivered to an ultimate purchaser. FIRMAN warrants to the ultimate purchaser and each subsequent purchaser that the engine is:

Designed, built, and equipped so as to conform with all applicable regulations adopted by the Air Resources Board and US EPA; and Free from defects in materials and workmanship that cause the failure of a warranted part to be identical in all material respects to the part as described in the engine manufacturers application for certification.

The warranty on emissions-related parts is as follows:

- (1) Any warranted part that is not scheduled for replacement as required maintenance in the owner's manual supplied, is warranted for the warranty period stated above. If any such part fails during the period of warranty coverage, the part will be repaired or replaced by FIRMAN at no charge to the owner. Any such part repaired or replaced under the warranty will be warranted for the remaining warranty period.
- (2) Any warranted part that is scheduled only for regular inspection in the owner's manual supplied, is warranted for the warranty period stated above. Any such part repaired or replaced under warranty will be warranted for the remaining warranty period.
- (3) Any warranted part that is scheduled for replacement as required maintenance in the owner's manual supplied, is warranted for the period of time prior to the first scheduled replacement point for that part. If the part fails prior to the first scheduled replacement, the part will be repaired or replaced by FIRMAN at no charge to the owner. Any such part repaired or replaced under warranty will be warranted for the remainder of the period prior to the first scheduled replacement point for the part.
- (4) Repair or replacement of any warranted part under the warranty must be performed at no charge to the owner at a warranty station.
- (5) Notwithstanding the provisions of Subsection (4) above, warranty services or repairs must be provided by FIRMAN that are franchised to service the subject engines.
- (6) The owner must not be charged for diagnostic labor that leads to the determination that a warranted part is in fact defective, provided that such diagnostic work is performed at a warranty station.
- (7) FIRMAN is liable for damages to other engine components proximately caused by a failure under warranty of any warranted part.

Service - Warranty

(8) Throughout the emissions warranty period defined in Subsection (b)(2), FIRMAN will maintain a supply of warranted parts sufficient to meet the expected demand for such parts.

(9) Any replacement part may be used in the performance of any warranty maintenance or repairs and must be provided without charge to the owner. Such use will not reduce the warranty obligations of the manufacturer.

(10) Add-on or modified parts that are not exempted by the Air Resources Board may not be used. The use of any non-exempted add-on or modified parts by the ultimate purchaser will be grounds for disallowing a warranty claim.

The manufacturer will not be liable to warrant failures of warranted parts caused by the use of a non-exempted add-on or modified part.

PARTS COVERED BY WARRANTY

Listed below are the parts (if equipped) covered by the Federal and California Emission Control System Warranty.

1. Ignition system including: <ul style="list-style-type: none">- Spark plug- Ignition coil	4. Air induction system including: <ul style="list-style-type: none">- Intake pipe/manifold- Air cleaner
2. Fuel metering system: <ul style="list-style-type: none">- Fuel tank- Fuel cap- Fuel lines (for liquid fuel and fuel vapors) and related fittings/clamps- Fuel regulator, carburetor and internal parts.	5. Crankcase breather assembly including: <ul style="list-style-type: none">- Breather connection tube
3. Catalytic muffler assembly including: <ul style="list-style-type: none">- Exhaust manifold- Catalytic converter- Muffler gasket-pulse valve	6. Fuel tank evaporative emission control system including: <ul style="list-style-type: none">- Purge valves- Carbon canister- Vapor hoses and fitting/clamps

Limitations

This Emission Control System Warranty shall not cover any of the following:

- (a) Consequential damages such as loss of time, inconvenience, loss of use of the engine or equipment, etc.
- (b) Diagnosis and inspection fees that do not result in eligible warranty service being performed.

FIRMAN POWER EQUIPMENT INC.

www.firmanpowerequipment.com

FOLLOW US ON SOCIAL

USE

#EVERYGENERATORTELLSASTORY™

FOR YOUR CHANCE TO WIN FIRMAN SWAG



FIRMAN POWER EQUIPMENT INC.
8644 W. LUDLOW DR.
PEORIA, AZ 85381
1-844-347-6261
WWW.FIRMANPOWEREQUIPMENT.COM

All rights reserved. Any reprinting or unauthorized use without the written permission is expressly prohibited.
P/N:380747010 Rev:01